

Field Manual for Erosion and Sediment Control In Georgia

Fourth Edition
2002



Georgia Soil and Water Conservation Commission

4310 Lexington Road

P.O. Box 8024

Athens, GA 30603

706-542-3065

Fax 706-542-4242

www.gaswcc.org

The preparation of this Field Manual was financed in part through a grant from the U.S. Environmental Protection Agency to the Environmental Protection Division of the Georgia Department of Natural Resources under Provisions of Section 319(h) of the Federal Water Pollution Control Act, as amended.

All programs and services of the federal, state and local agencies listed above are available on a nondiscriminatory basis without regard to race, color, national origin, religion, sex, age, marital status, handicap or disability. If you need this document in an alternative format, call (706) 542-3065

2005

(This page left blank intentionally.)

TABLE OF CONTENTS

	Page
Introduction	vi
Vegetative Best Management Practices	
Bf	Buffer Zone 2
Cs	Coastal Dune Stabilization 6
Ds1	Disturbed Area Stabilization (With Mulching Only) 10
Ds2	Disturbed Area Stabilization (With Temporary Seeding) 12
Ds3	Disturbed Area Stabilization (With Permanent Vegetation) 18
Ds4	Disturbed Area Stabilization (With Sodding) 28
Du	Dust Control on Disturbed Areas 32
Mb	Erosion Control Matting and Blankets 34
Pm	Polyacrylamide (PAM) 38
Sb	Streambank Stabilization (With Permanent Vegetation) 40
Tb	Tackifiers and Binders 48
	Major Land Resource Area Map 50
Structural Best Management Practices	
Cd	Check Dam 52
Ch	Channel Stabilization 54
Co	Construction Exit 56
Cr	Construction Road Stabilization 58
Dc	Stream Diversion Channel 60
Di	Diversion 64
Dn1	Temporary Downdrain Structure 66
Dn2	Permanent Downdrain Structure 70
Fr	Filter Ring 72
Ga	Gabion 74

TABLE OF CONTENTS

	Page
(Gr) Grade Stabilization Structure	76
(Lv) Level Spreader	78
(Rd) Rock Filter Dam	80
(Re) Retaining Wall	82
(Rt) Retrofit	84
(Sd1) Sediment Barrier	88
(Sd2) Inlet Sediment Trap	94
(Sd3) Temporary Sediment Basin	100
(Sr) Temporary Stream Crossing	106
(St) Storm Drain Outlet Protection	110
(Su) Surface Roughening	114
(Tp) Topsoiling	118
(Wt) Vegetated Waterway or Stormwater Conveyance Channel	120
The Erosion and Sediment Control Act of 1975, as amended	124
National Pollution Discharge Elimination System (NPDES) Permit	131
Construction Checklist	132
Glossary	146
Points of Contact	155

INTRODUCTION

The First Edition of this Field Manual was printed in 1979 and revised in 1988, 1997 and 2002. Georgia's Erosion and Sedimentation Law has been amended several times since with major changes to the Law occurring in 1994, 1995 and 2000. The emphasis shifted from water quality to meeting "minimum requirements." This means that Best Management Practices (BMPs) must be properly designed, installed and maintained in accordance with sound conservation and engineering principals.

This Field Manual has been prepared primarily to assist field personnel involved in on-site land-disturbing activities. It should be helpful as a quick reference in the actual installation and maintenance of BMPs. (The inclusion of detailed design information has purposely been kept to a minimum.) For more detailed information, The Manual for Erosion and Sediment Control in Georgia should be consulted.

BMPs are vegetative measures and structural practices that control the erosion of soil and the resulting sedimentation. The law mandates that all BMPs stand up to a 25-year rainfall event or the land-disturber is subject to severe civil penalties.

Good erosion control and sediment reduction does not require a rocket scientist or a "legal eagle." The key to well-planned land-disturbing activities is well-informed managers in the field; the individuals for whom this manual is written. Common sense and a working knowledge of the tools nature has provided will lead to good site development.

Georgia's Law is called the "Erosion and Sedimentation Act." Erosion and sedimentation are two separate processes. If erosion is controlled, sediment is not produced. Therefore, to practice good erosion and sediment control (E&SC), emphasis has to be placed on controlling erosion at the source. Sediment control should be considered the last line of defense. Allowing any erosion to occur is the first step towards noncompliance.

Complete erosion control usually does not involve engineered structures, just sensible planning and the immediate application of ground covers including mulch and vegetation. Nature has provided us with an abundance of trees, shrubs and grasses, all of which are effective erosion control tools. **USE THEM!** And use them wisely in a timely manner.

If your E&SC plan does not show a vegetative buffer around a site but there is an area on the perimeter that does not require clearing, then save the existing vegetation! A good vegetative buffer 25'-35' can trap 85-95% of the sediment in runoff water.

If a site is properly engineered, cut and fill slopes can be mulched or vegetated daily. Mulch does not require water or fertilizer or lime. A good application of mulch can reduce soil loss by up to 98%. When in doubt, mulch!

Use conventional planting methods, when feasible. Sodding may initially be more expensive...but how much more? If a site has to be re-planted several times, then it just may be cheaper to sod rather than seed bare slopes. Even if the sod should die, most sodded areas will protect bare areas from erosion during the duration of the land-disturbing activity.

To summarize, save as much existing vegetation as possible and mulch/vegetate as early and as frequently as possible. Also, as a last line of defense, install traps for sediment as soon as possible. This will lead to good erosion and sediment control on any site.

The BMPs listed in this manual are intended to provide minimum control for erosion and sedimentation problems as required by State Law. However, other measures and innovative practices that are at least as effective as the listed practices are encouraged. Also, while the emphasis is on meeting the requirements of the State Law, land disturbers must also comply with all other local, state and federal laws including that of the Army Corps of Engineers (COE) on Section 404. Local Issuing Authorities must ensure compliance on all regulations before issuing a land disturbing activity (LDA) permit.

The Commission is grateful to the several reviewers who assisted in the preparation of this publication. We welcome notice of any errors or omissions we may correct in our next publication.

Throughout the Manual, many provisions of the E&SC Law and resulting rules and regulations have been paraphrased or shortened for convenience. Any interpretations or opinions expressed in this shortened format are those of the Commission and are provided for quick reference only. In matters of litigation, the Law and the Courts are the final word.

VEGETATIVE BEST MANAGEMENT PRACTICES

Bf	Buffer Zone	2
Cs	Coastal Dune Stabilization	6
Ds1	Disturbed Area Stabilization (With Mulching Only)	10
Ds2	Disturbed Area Stabilization (With Temporary Seeding)	12
Ds3	Disturbed Area Stabilization (With Permanent Vegetation)	18
Ds4	Disturbed Area Stabilization (With Sodding)	28
Du	Dust Control on Disturbed Area	32
Mb	Erosion Control Matting and Blankets	34
Pm	Polyacrylamide (PAM)	38
Sb	Streambank Stabilization (With Permanent Vegetation)	40
Tb	Tackifiers and Binders	48
	Major Land Resource Area Map	50

DEFINITION

An undisturbed or planted vegetative strip around a site or bordering a stream.

***PURPOSE***

- Filter sediment.
- Filter chemicals, nutrients, and germs.
- Reduce runoff velocities.
- Stabilize stream banks.
- Improve aesthetics.
- Improve fish and wildlife habitat.
- Reduce construction noise.
- Flood protection.

INSTALLATION

- Install according to approved plan, if shown.
- Mark vegetation to be retained with fencing or highly visible marks (tape, paint, etc.).
- See Section 12-7-6 of E&SC Law and local ordinances for minimum stream buffer widths.
- Three kinds of buffer vegetation are trees, shrubs and grasses.

- A good buffer properly installed and maintained can filter out 85-95% of sediment in runoff.
- Good vegetative buffers are much more durable than sediment barriers and won't fail after a moderate storm.

Table 1. Effectiveness of Vegetative Buffer Strips

Purpose	Grass	Shrub	Tree
Filter sediment	High	Low	Low
Filter chemicals	Medium	Low	Low
Stabilize stream banks	Low	High	High
Improve aesthetics	Low	Medium	High
Improve habitat	Low	Medium	High
Reduce noise	Low	Medium	High

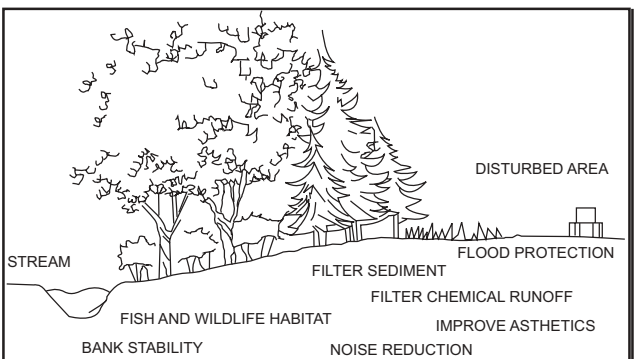

Figure 1. Some Benefits of a Riparian Buffer

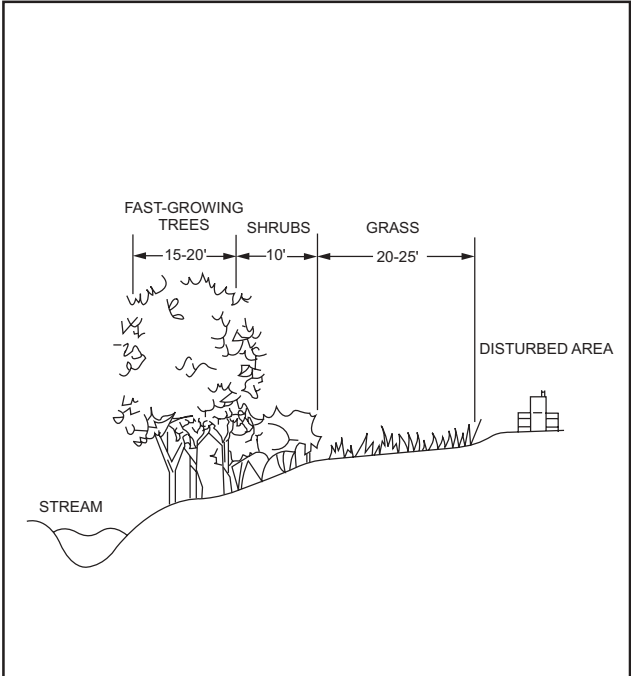

Figure 2. Typical Multi-Purpose Riparian Buffer for Urban Development

MAINTENANCE

- Lime and fertilize appropriately.
- Control weeds to promote desired vegetation.
- Use mulches when establishing new vegetation.
- Remove sediments when buffer effectiveness is reduced or lost.
- Protect trees and shrubs from wildlife and equipment.
- Check local ordinances for local buffer requirements.

REFERENCES

- Ds1 Disturbed Area Stabilization
(With mulching only)
- Ds2 Disturbed Area Stabilization
(With temporary seeding)
- Ds3 Disturbed Area Stabilization
(With permanent seeding)
- Sb Streambank Stabilization
(With permanent vegetation)

COASTAL DUNE STABILIZATION (WITH VEGETATION)

DEFINITION

Planting vegetation on bare dunes or where dunes are to be established.



PURPOSE

- Prevent dune erosion from wind or waves by planting vegetation.
- Provide for the development or enhancement of dunes.

INSTALLATION

- Install in accordance with an approved design/study.
- Install in accordance with all federal, state and local regulations.
- Protect dunes from vehicular and human traffic.
- Irrigate during the first year to obtain good survival.
- Mulch areas to be planted.
- Native plants commercially available that may be planted are included in Table 1.

Table 1.
Planting Requirements for Native Plants

Species	Stock	Date	Depth
Marshhay Cordgrass (<i>Spartina patens</i>)	Plants	Spring	4"-5"
Bitter Panicum (<i>Panicum amarum</i>)	Rhizomes	Spring	Abt 4"
Coastal Panigrass (<i>Panicum amarum</i> v. <i>amaralum</i>)	Seeds or plants	Spring	1"-3"



Figure 1. Sand Fence and Native Plants

Sand Fences

- Install according to plans, if shown.
- Use posts made of Black Locust, Red or White Cedar, or similarly durable wood.
- Use posts with minimum length of 7 feet and minimum diameter of 3 inches.
- Space posts at a maximum of 10 feet.
- Entrench posts a minimum of 3 feet.
- Attach fence to posts with four 12-gauge galvanized wires.

- Vegetation must be established immediately following development of the dunes.
- Sand fences should be the same as commercially available snow fence approximately as shown in Figure 2.

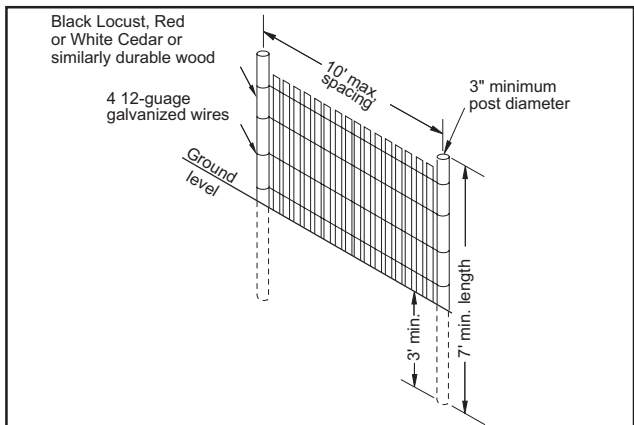

Figure 2. Sand Fence Installation Requirements

MAINTENANCE

- Blowouts and eroded areas should be repaired promptly.
- Add fencing, if needed, or use equipment to make repairs.
- Replant lost or destroyed vegetation.
- Apply 50 pounds of nitrogen/acre/year.
- Protect dunes from traffic by using paved paths, elevated or roll-up walks.

(This page left blank intentionally.)

DISTURBED AREA STABILIZATION (WITH MULCHING ONLY)

DEFINITION

A temporary cover of plant residues applied to the soil surface for a period of six (6) months or less when seeding is not practical.



PURPOSE

- Reduce runoff, erosion, and sedimentation.
- Reduce dust.
- Conserve moisture.
- Prevent surface compaction and crusting.
- Control undesirable vegetation.

INSTALLATION

- Install all other required BMPs first.
- Grade site, if possible, to permit the use of equipment for applying and anchoring mulch.
- Loosen compacted soil, if possible, to a depth of three (3) inches.
- Apply straw or hay uniformly, as shown in Table 1, by hand or mechanical equipment, and anchor by pressing into soil or using netting.

- Mulch on slopes greater than 3% should be anchored with emulsified asphalt (Grade AE-5 or SS-1) or other suitable tackifier.
- Wood waste on slopes flatter than 3:1 do not need anchoring.
- Mulch shall be applied to all disturbed areas left inactive for fourteen days.

Table 1. Mulching Application Requirements

Material	Rate	Depth
Straw or hay	-	2" to 4"
Wood waste, chips, sawdust, bark	-	2" to 3"
Cutback asphalt	1200 gal./acre, 1/4 gal./sq. yd. or See manufacturer's recommendations	---
Polyethylene film	Secure with soil, anchors, weights	---
Geotextiles, jute matting, netting, etc.	See manufacturer's recommendations	---

MAINTENANCE

- Add mulch as needed to maintain the suggested depth.
- If organic mulch is to be left and incorporated into the soil, apply 20-30 pounds of Nitrogen in addition to the fertilizer required for vegetation.

REFERENCES

- **Mb** Erosion Control Matting and Blankets

Ds2

DISTURBED AREA STABILIZATION (WITH TEMPORARY SEEDING)

DEFINITION

A temporary vegetative cover with fast growing seedings for up to a 12-month period or until permanent vegetation is established.



PURPOSE

- Reduce runoff, erosion, and sedimentation.
- Improve wildlife habitat.
- Improve aesthetics.
- Improve tilth and organic matter.

INSTALLATION

- Install all E&SC measures prior to applying temporary vegetation.
- Grading or shaping are not required if slopes can be planted with a hydroseeder or by hand-seeding.
- Seedbed preparation is not required if soil is loose and not sealed by rain.

- When the soil is sealed or crusted, it should be pitted, trenched or scarified to provide a place for seed to lodge and germinate.
- Agricultural lime is not required.
- Fertilize low fertility soils prior to or during planting at the rate of 500-700 pounds per acre of 10-10-10 fertilizer or equivalent (12-16 pounds/1000 square feet).
- It is imperative that you check the tag on the bag of seed to verify the type and germination of the seed to be planted.



Figure 1. Typical Tag on Bag of Seed

- Apply seed by hand, cyclone seeder, drill or hydro-seeder. Seed planted with a drill should be planted 1/4"-1/2" deep. Refer to Pure Live Seed (PLS) in the Glossary.
- Apply in accordance with specifications on the E&SC plan. If information is not available, select a temporary cover from Table 1.
- Temporary cover shall be applied to all disturbed areas left idle for fourteen days. (If an area is left idle for 6 months, permanent cover shall be applied.)

Ds2

MAINTENANCE

- Re-seed areas where an adequate stand of temporary vegetation fails to emerge or where a poor stand exists.

REFERENCES

- Mb Erosion Control Matting and Blankets
- Ds1 Disturbed Area Stabilization
(With mulching only)
- Pm Polyacrylamide (PAM)

Table 1. Some Temporary Plant Species, Seeding Rates and Planting Dates

Species	Rates Per 1,000 sq. ft.	Rates per Acre	Planting Dates by Region		
			M - L	P	C
Barley Alone Barley In mixtures	3.3 lbs. .6 lbs.	3 bu. .5 bu.	9/1-10/31	9/15-11/15	10/1-12/31
Lespedeza, Annual Lespedeza In Mixtures	0.9 lbs. 0.2 lbs.	40 lbs. 10 lbs.	3/1-3/31	3/1-3/31	2/1-2/28
Lovegrass, Weeping Lovegrass In Mixtures	0.1 lbs. .05 lbs.	4 lbs. 2 lbs.	4/1-5/31	4/1-5/31	3/1-5/31
Millet, Browntop Millet In Mixtures	.9 lbs. .2 lbs.	40 lbs. 10 lbs.	4/15-6/15	4/15-6/30	4/15-6/30
Millet, Pearl	1.1 lbs.	50 lbs.	5/15-7/15	5/1-7/31	4/15-8/15

1. Unusual site conditions may require heavier seeding rates.
2. Seeding dates may need to be altered to fit temperature variations and local conditions.
3. For Major Land Resource Areas (MLRAs), see page 50.
4. Seeding rates are based on pure live seed (PLS).

Table 1. Some Temporary Plant Species, Seeding Rates and Planting Dates (continued)

Species	Rates Per 1,000 sq. ft.	Rates per Acre	Planting Dates by Region		
			M - L	P	C
Oats Alone	2.99 lbs.	4 bu.	9/15-11/15	9/15-11/15	9/15-11/15
Oats In Mixtures	.7 lbs.	1 bu.			
Rye (Grain) Alone	3.9 lbs.	3 bu.	8/15-10/31	9/15-11/30	10/1-12/31
Rye In Mixtures	.6 lbs.	.5 bu.			
Ryegrass	0.9 lbs.	40 lbs.	8/15-11/15	9/1-12/15	9/15-12/31
Sudangrass	1.4 lbs.	60 lbs.	5/1-7/31	5/1-7/31	4/1-7/31
Triticale Alone	3.3 lbs.	3 bu.	NA	NA	10/15-11/30
Triticale In Mixtures	.6 lbs.	.5 bu.			
Wheat Alone	4.1 lbs.	3 bu.	9/15-11/30	10/1-12/15	10/15-12/31
Wheat In Mixtures	.7 lbs.	.5 bu.			

1. Unusual site conditions may require heavier seeding rates.
2. Seeding dates may need to be altered to fit temperature variations and local conditions.
3. For Major Land Resource Areas (MLRAs), see page 50.
4. Seeding rates are based on pure live seed (PLS).

Table 2. Fertilizer Requirements for Temporary Vegetation

Types of Species	Planting Year	Fertilizer (N-P-K)	Rate (lbs./acre)	N Top Dressing Rate (lbs./acre)
Cool season grasses	First	6-12-12	1500	50-100
	Second	6-12-12	1000	---
	Maintenance	10-10-10	400	30
Cool season grasses & legumes	First	6-12-12	1500	0-50
	Second	0-10-10	1000	---
	Maintenance	0-10-10	400	---
Temporary cover crops seeded alone	First	10-10-10	500	30
Warm season grasses	First	6-12-12	1500	50-100
	Second	6-12-12	800	50-100
	Maintenance	10-10-10	400	30

DISTURBED AREA STABILIZATION (WITH PERMANENT SEEDING)

DEFINITION

A permanent vegetative cover using grasses, trees, shrubs or legumes on highly erodible or critically eroded lands.



PURPOSE

- Reduce runoff and erosion.
- Improve wildlife habitat.
- Improve aesthetics.
- Improve tilth and organic matter.
- Reduce downstream complaints.
- Reduce likelihood of legal action.
- Reduce likelihood of work stoppage due to legal action.
- Increase “good neighbor” benefits.

INSTALLATION

- Use conventional planting methods, if possible.
- Apply according to approved plan, if shown, or refer to Table 1.

- Check the tag on the bag of seed to verify the type and germination of the seed to be planted and the date of the test.

Figure 1. Typical Tag on a Bag of Seed



- Scarify, pit or trench sealed or crusted soil.
- Fertilize based on soil tests or as shown in Table 2.
- Apply agricultural lime as prescribed by soil tests or at a rate of 1 to 2 tons per acre.
- Apply seed by hand, cyclone seeder, drill or hydro-seeder. Seed planted with a drill should be planted 1/4"-1/2" deep.
- Straw or hay mulch shall be applied at a rate of 2 or 2.5 tons per acre.
- Irrigation should be used to supplement rainfall, but not to the extent to cause erosion.

Table 1. Some Permanent Plant Species, Seeding Rates, and Planting Dates

DS3

Species	Rates per Acre	Rates per 1,000 sq. ft	Planting Dates by Region			Remarks
			M-L	P	C	
Bahia, Pensacola Alone or with temporary cover With other perennials	60 lbs.	1.4 lbs.	---	4/1-5/31	3/1-5/31	Low growing; sod producing; will spread into Bermuda lawns.
	30 lbs.	0.7 lb.				
Bahia, Wilmington Alone or with temporary cover With other perennials	60 lbs.	1.4 lbs.	3/15-5/31	3/1-5/31	---	Same as above.
	30 lbs.	0.7 lb.				
Bermuda, Common (Hulled seed) Alone With other perennials	10 lbs.	0.2 lb.	---	4/1-5/31	3/15-5/31	Quick cover; low growing; sod forming; needs full sun.
	6 lbs.	0.1 lb.				
Bermuda, Common (Unhulled seed) With temporary cover With other perennials	10 lbs.	0.2 lb.	---	10/1-2/28	11/1-1/31	Plant with Winter annuals. Plant with Tall Fescue
	6 lbs.	0.1 lb.				
Bermuda Sprigs Common lawn and forage hybrids	40 cu. ft.	0.9 cu. ft.	4/15-6/15	4/1-6/15	4/1-5/31	1 cu. ft. = 650 sprigs; 1 bu. = 1.25 cu. ft. or 800 sprigs
	Sod plugs 3'x3'					

Table 1. Some Permanent Plant Species, Seeding Rates, and Planting Dates (continued)

Species	Rates per Acre	Rates per 1,000 sq. ft	Planting Dates by Region			Remarks
			M-L	P	C	
Centipede	Block Sod Only	Block Sod Only	-	11/1-5/31	11/1-5/31	Drought tolerant. Full sun or partial shade.
Crown Vetch With winter annuals or cool season grasses	15 lbs.	0.3 lb.	9/1-10/15	9/1-10/15	---	Mix with 30 lbs. Tall Fescue or 15 lbs. Rye; inoculate seed; plant only North of Atlanta.
Fescue, Tall Alone With other perennials	50 lbs. 30 lbs.	1.1 lbs. 0.7 lb.	3/1-4/15 or 8/15-10/15	9/1-10/15	---	Can be mixed with perennial Lespedezas or Crown Vetch; not for droughty soils or heavy use areas.
Lespedeza, Sericea Scarified	 60 lbs.	 1.4 lbs.	 4/1-5/31	 3/15-5/31	 3/1-5/15	Widely adapted and low maintenance; takes 2-3 years to establish; inoculate seed with EL inoculant.; mix with Weeping Lovegrass, Common Bermuda, Bahia or Tall Fescue.

Table 1. Some Permanent Plant Species, Seeding Rates, and Planting Dates (continued)

DS3

Species	Rates per Acre	Rates per 1,000 sq. ft	Planting Dates by Region			Remarks
			M-L	P	C	
Lespedeza, Sericea (cont.)						
Unscarified	75 lbs.	1.7 lbs.	9/1-2/28	9/1-2/28	9/1-2/28	Mix with Tall Fescue or winter annuals.
Seed-bearing hay	3 tons	138 lbs.	10/1-2/28	10/1-1/31	10/15-1/15	Cut when seed is mature but before it shatters. Add Tall Fescue or winter annuals.
Lespedeza, Ambro Virgata or Appalow						
Scarified	60 lbs.	1.4 lbs.	4/1-5/31	3/15-5/31	3/1-5/15	Spreading growth with height of 18"-24"; good in urban areas; slow to develop good stands; mix with Weeping Lovegrass, Common Bermuda, Bahia Tall Fescue or winter annuals; do not mix with Sericea Lespedeza; inoculate seed with EL inoculant.
Unscarified	75 lbs.	1.7 lbs.	9/1-2/28	9/1-2/28	9/1-2/28	

Table 1. Some Permanent Plant Species, Seeding Rates, and Planting Dates (continued)

Species	Rates per Acre	Rates per 1,000 sq. ft	Planting Dates by Region			Remarks
			M-L	P	C	
Lespedeza, Shrub (Lespedeza Bicolor or Lespedeza Thumbergii) Plants	3'x3' spacing		10/1-3/31	11/1-3/15	11/15-2/28	Plant in small clumps for wildlife food and cover.
Lovegrass, weeping Alone With other perennials	4 lbs. 2 lbs.	0.1 lbs. 0.05 lbs.	4/1-5/31	3/15-5/31	3/1-5/31	Quick cover; drought tolerant; grows well with Sericea Lespedeza on road-banks and other steep slopes; short lived.
Maidencane sprigs	2'x3' spacing		2/1-3/31	2/1-3/31	2/1-3/31	For very wet sites such as riverbanks and shorelines. Dig sprigs locally.
Panicgrass, Atlantic Coastal	20 lbs.	0.5 lbs.	---	3/1-4/30	3/1-4/30	Grows well on coastal sand dunes; mix with Sericea Lespedeza but not on sand dunes.

Table 1. Some Permanent Plant Species, Seeding Rates, and Planting Dates (continued)

Species	Rates per Acre	Rates per 1,000 sq. ft	Planting Dates by Region			Remarks
			M-L	P	C	
Reed Canary Grass With other perennials	50 lbs. 30 lbs.	1.1 lbs. 0.7 lbs.	8/15-10/15	9/1-10/15	---	Grows similar to Tall Fescue; for wet sites.
Sunflower, Aztec Maximillian	10 lbs.	0.2 lbs.	4/15-5/31	4/15-5/31	4/1-5/31	Mix with Weeping Lovegrass or other low growing grasses or legumes.

1. Rates are for broadcasted seed. If a seed drill is used, reduce the rates by one-half.
2. PLS is an abbreviation for Pure Live Seed. Refer to the Glossary for an explanation of this term.
3. The resource areas are defined in the Glossary. See page 50 for your Resource Area.
4. Seeding rates are based on pure live seeds (PLS).

Table 2. Fertilizer Requirements for Temporary Vegetation

Types of Species	Planting Year	Fertilizer (N-P-K)	Rate (lbs./acre)	N Top Dressing Rate (lbs./acre)
Cool season grasses	First	6-12-12	1500	50-100
	Second	6-12-12	1000	---
	Maintenance	10-10-10	400	30
Cool season grasses & legumes	First	6-12-12	1500	0-50
	Second	0-10-10	1000	---
	Maintenance	0-10-10	400	---
Warm season grasses	First	6-12-12	1500	50-100
	Second	6-12-12	800	50-100
	Maintenance	10-10-10	400	30
Warm season grasses and legumes	First	6-12-12	1500	50
	Second	0-10-10	1000	---
	Maintenance	0-10-10	400	---



Figure 2. Crown Vetch



Figure 3. Sericea Lespedeza

MAINTENANCE

- Re-seed areas where an adequate stand of vegetation fails to emerge or where a poor stand exists.
- Apply fertilizer per Table 2.
- Apply one ton of agricultural lime or as indicated by soil test every 4-6 years.
- Mow Bermuda and Bahia as desired. Mow Sericea Lespedeza only after frost to ensure seeds are mature.
- Maintain 6" or more of top growth.

REFERENCES

- Mb Erosion Control Matting and Blankets
- Ds1 Disturbed Area Stabilization
(With mulching only)
- Ds2 Disturbed Area Stabilization
(With temporary seeding)

Ds4

DISTURBED AREA STABILIZATION (WITH SODDING)

DEFINITION

A permanent vegetation using sods on highly erodible or critically eroded lands.



PURPOSE

- Establish immediate ground cover.
- Reduce runoff and erosion.
- Improve aesthetics and land value.
- Reduce dust and sediments.
- Stabilize waterways and critical areas.
- Filter sediments, nutrients and bugs.
- Reduce downstream complaints.
- Reduce likelihood of legal action.
- Reduce likelihood of work stoppage due to legal action.
- Increase “good neighbor” benefits.

INSTALLATION

- Bring soil surface to final grade. Clear surface of trash, woody debris, stones and clods larger than 1". Apply sod to soil surfaces only and not frozen surfaces, or gravel type soils

- Topsoil properly applied will help guarantee a stand. Don't use topsoil recently treated with herbicides or soil sterilants.
- Mix fertilizer into soil surface. Fertilize based on soil tests or Table 1. For fall planting of warm season species, half the fertilizer should be applied at planting and the other half in the spring.

Table 1. Fertilizer Requirements for Soil Surface Application

Fertilizer Type (lbs./acre)	Fertilizer Rate (lbs./sq. ft.)	Fertilizer Rate	Season
10-10-10	1000	.025	Fall

- Agricultural lime should be applied based on soil tests or at a rate of 1 to 2 tons per acre.
- Lay sod with tight joints and in straight lines. Don't overlap joints. Stagger joints and do not stretch sod.
- On slopes steeper than 3:1, sod should be anchored with wooden or biodegradable pins or other approved methods.
- Installed sod should be rolled or tamped to provide good contact between sod and soil.
- Irrigate sod and soil to a depth of 4" immediately after installation.
- Sod should not be cut or spread in extremely wet or dry weather.
- Irrigation should be used to supplement rainfall for a minimum of 2-3 weeks.

MATERIALS

- Sod selected should be certified. Sod grown in the general area of the project is desirable.

Ds4

- Sod should be machine cut and contain 3/4" ±1/4" of soil, not including shoots or thatch.
- Sod should be cut to the desired size within ±5%. Torn or uneven pads should be rejected.
- Sod should be cut and installed within 36 hours of digging.
- Avoid planting when subject to frost heave or hot weather if irrigation is not available.
- The sod type should be shown on the plans or installed according to Table 2. See page 50 for your Resource Area.

Table 2. Sod Planting Requirements

Grass	Varieties	Resource Area	Growing Season
Bermudagrass	Common Tifway Tifgreen Tiflawn	M-L, P,C P,C P,C P,C	Warm weather
Bahiagrass	Pensacola	P,C	Warm weather
Centipede	---	P,C	Warm weather
St. Augustine	Common Bitterblue Raleigh	C	Warm weather
Zoysia	Emerald Myer	P,C	Warm weather
Tall Fescue	Kentucky 31	M-L, P	Cool weather

MAINTENANCE

- Re-sod areas where an adequate stand of sod is not obtained.

- New sod should be mowed sparingly. Grass height should not be cut less than 2"-3" or as specified.
- Apply one ton of agricultural lime as indicated by soil test or every 4-6 years.
- Fertilize grasses in accordance with soil tests or Table 3.

Table 3. Fertilizer Requirements for Sod

Types of Species	Planting Year	Fertilizer (N-P-K)	Rate (lbs./acre)	Nitrogen Top Dressing Rate (lbs./acre)
Cool season grasses	First	6-12-12	1500	50-100
	Second	6-12-12	1000	---
	Maintenance	10-10-10	400	30
Warm season grasses	First	6-12-12	1500	50-100
	Second	6-12-12	800	50-100
	Maintenance	10-10-10	400	30

REFERENCES

- Mb Erosion Control Matting and Blankets
- Ds1 Disturbed Area Stabilization (With mulching only)
- Ds2 Disturbed Area Stabilization (With temporary seeding)
- Ds3 Disturbed Area Stabilization (With permanent seeding)

DUST CONTROL ON DISTURBED AREAS

DEFINITION

Controlling surface and air movement of dust on land-disturbing activities.



PURPOSE

- Prevent the movement of dust from exposed soil surfaces.
- Prevent the movement of airborne substances that may be harmful to health.

INSTALLATION

- Apply according to approved plan, if shown.
- Mulch disturbed areas and tackify with resins such as asphalt, Curasol or Terratack according to manufacturer's recommendations.
- Stabilize disturbed areas with temporary or permanent vegetation.
- Irrigate disturbed areas until surface is wet.
- Cover surfaces with crushed stone or gravel.

- Apply calcium chloride at a rate to keep surfaces moist.
- Apply spray-on adhesives to mineral soils (not muck soils) as described in Table 1.

Table 1. Spray-On Adhesive Application Requirements

Adhesive	Water Dilution	Nozzle Type	Application (Gal./Acre)
Anionic asphalt emulsion	7:1*	Coarse spray	1,200
Latex emulsion	12.5:1 *	Fine spray	235
Resin-in-water emulsion	4:1*	Fine spray	300

*Use manufacturer’s recommendations when available.

MAINTENANCE

- Prohibit traffic on surface after spraying.
- Supplement surface covering as needed.

REFERENCES

- **Ds1** Disturbed Area Stabilization (With mulching only)
- **Ds2** Disturbed Area Stabilization (With temporary seeding)
- **Ds3** Disturbed Area Stabilization (With permanent seeding)
- **Ds4** Disturbed Area Stabilization (With sodding)
- **Tb** Tackifiers and Binders

EROSION CONTROL MATTING AND BLANKETS

DEFINITION

A protective covering (blanket) or soil stabilization mat used to establish permanent vegetation on steep slopes, channels, or shorelines.



PURPOSE

- Reinforce turf.
- Reduce erosion.
- Reinforce channels.
- Provide protective covering.

INSTALLATION

- Install on slopes steeper than 2.5:1 and greater than 10 feet in height and in areas of concentrated flow.
- Install according to approved plan, if shown.
- All mats and netting should be appropriately staked to prevent shifting.
- These materials must be installed according to the manufacturer's specifications.

Jute or Excelsior (Wood Fiber) Matting

- Seed area.
- Cover an area completely with a heavy, uniform, jute yarn or organic mulch.
- Apply on areas with steep slopes, water-courses or where vegetation needs to be quickly established.



Figure 1. Installation of Jute Matting

Fiberglass Roving

- Seed area.
- Apply fiberglass with a compressed air ejector, at a rate of 1/2-1 ton per acre and tack with emulsifier (asphalt) at a rate of 25-35 gal/1000 ft² or as recommended by the manufacturer.
- Place in watercourses or on moderate slopes for stabilization and to provide a suitable microclimate for seeds.

Bonded Fiber Matrix

- A hydraulically applied bonded fiber matrix which upon drying shall adhere to the soil in the form of a continuous 100 per cent coverage biodegradable blanket.
- The bonded matrix shall not be applied on saturated soils.
- See manufacturer's specifications for installation instructions.

Turf Reinforcement Mats

- See manufacturer's specifications for installation instructions.
- Other geotextiles include silt fence, geoblocks, weight-bearing fabric, etc.
- All blanket and matting materials shall be on the Georgia Department of Transportation Qualified Products List (QPL #62 for blankets and QPL #49 for matting).



Figure 2. Geotextile Installed to Control Erosion in a Concentrated Flow Area

MAINTENANCE

- Inspect periodically and after each rainstorm until vegetation is completely established.
- Eroded or exposed areas should be seeded and stabilized with mulch as quickly as possible.

(This page left blank intentionally.)

POLYACRYLAMIDE (PAM)

DEFINITION

The land application of a product containing anionic polyacrylamide (PAM) acting as a temporary soil binding agent to reduce soil erosion.

PURPOSE

PAM is used to reduce erosion from wind and water on construction sites and agricultural lands. Other benefits may include improved water quality, infiltration, soil fertility, and visibility.

INSTALLATION

- Apply according to approved plan, if shown.
- These materials should be applied according to the manufacturer's specifications. These products are site specific.
- Use setbacks when applying anionic PAM near natural waterbodies.
- Never add water to PAM, add PAM slowly to water. If water is added to PAM, "globs" may form which can clog dispensers.
- NOT ALL POLYMERS ARE PAM.
- Only anionic PAM shall be used. Cationic PAM is toxic and shall not be used.

MAINTENANCE

Maintenance will consist of reapplying PAM to disturbed areas including high use traffic areas, which interfere in the performance of this practice.

(This page left blank intentionally.)

STREAMBANK STABILIZATION (USING PERMANENT VEGETATION)

DEFINITION

The use of readily available native plant materials to maintain and enhance streambanks, or to prevent, or restore and repair small streambank erosion problems.



PURPOSE

- Lessen the impact of rain directly on the soil.
- Trap sediment from adjacent land.
- Form a root mat to stabilize and reinforce the soil on the streambank.
- Provide wildlife habitat.
- Enhance the appearance of the stream.
- Lower summertime water temperatures for a healthy aquatic population.

NOTE: Careful thought, planning and execution is required to assure that the streambank stabilization project is done efficiently and correctly. Please refer to SSWCC's [Guidelines for Streambank Restoration](#) for more detailed information.

SELECTED MEASURES

- Revegetation includes seeding and sodding of grasses, seeding in combination with erosion control fabrics, and the planting of woody vegetation (shrubs and trees).
- Use jute mesh and other geotextiles to aid in soil stabilization and revegetation.

Live Stake

- Fresh, alive woody plant cuttings tamped into the ground as stakes, intended to root and grow into mature shrubs that will stabilize soils and restore the riparian zone habitats.
- Willow species work best.
- Provides no immediate streambank stabilization.

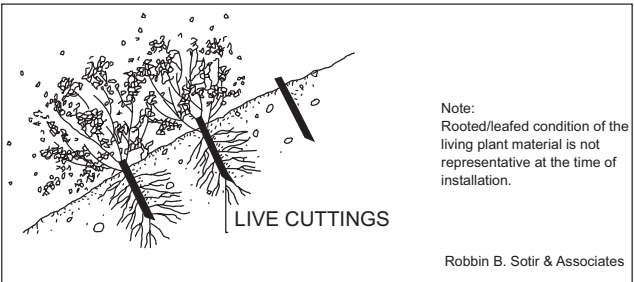

Figure 1. Illustration of a Live Stake

Joint Planting

- Installation of live willow stakes between rock previously placed along the streambank.
- Rock needs to be loosely dumped or hand placed and no thicker than 2 feet.
- Enables a bank previously installed with conventional rip-rap to become naturalized.

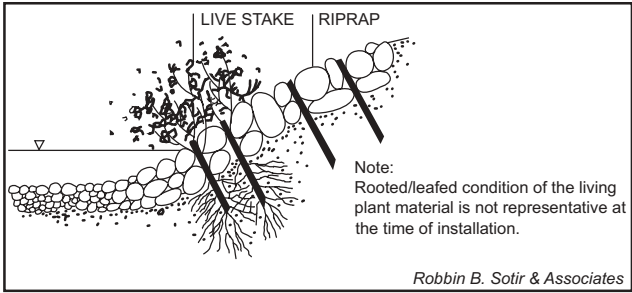

Figure 2. Illustration of Joint Planting

Live Fascine

- Sausage-like bundles of live cut branches placed into trenches along the streambank.
- Willow species work best.
- Provides immediate protection from erosion when properly used and installed.
- Creates very little site disturbance as compared to other systems.
- Works especially well when combined with surface covers such as jute mesh or coir fabrics.

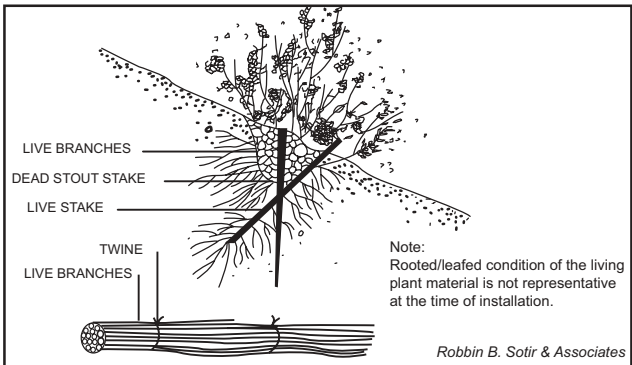

Figure 3. Illustration of a Live Fascine

Brushmattress

- Combination of living units that form an immediate protective surface cover over the streambank.
- Living units used include live stakes, live fascines, and a mattress branch cover (long, flexible branches placed against the bank surface).
- Requires a great deal of live material.
- Complicated and expensive to evaluate, design, and install.
- Captures sediment during flood conditions.
- Produces habitat rapidly, and quickly develops a healthy riparian zone.

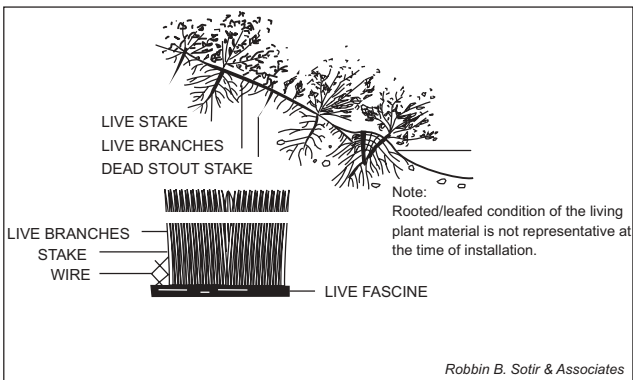

Figure 4. Illustration of a Brushmattress

Live Cribwall

- A rectangular framework of logs or timbers, rock, and woody cuttings.
- Requires a great deal of assessment and understanding of stream behavior.
- Can be complicated and expensive if a supply of wood and some volunteer help is not available.
- Develops a natural streambank or upland slope appearance after it has begun to grow.

- Provides excellent habitat for a variety of fish, birds, and animals.
- Very useful where space is limited on small, narrow stream corridors.

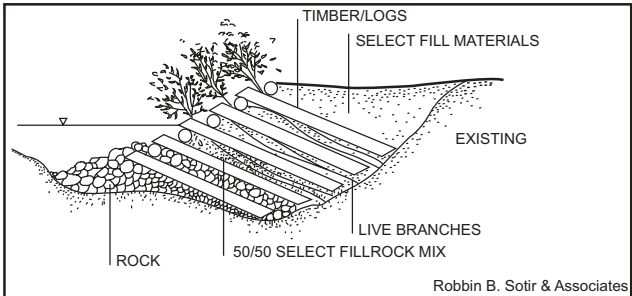

Figure 5. Illustration of a Live Cribwall

Branchpacking

- Process of alternating layers of live branches and soil, incorporated into a hole, gully, or slumped-out area in a slope or streambank.
- Moderate to complex level of difficulty for construction.
- Produces an immediate filter barrier, reducing scouring conditions, repairing gully erosion, and providing habitat cover and bank reinforcement.
- One of the most effective and inexpensive methods for repairing holes in earthen embankments along small stream sites.

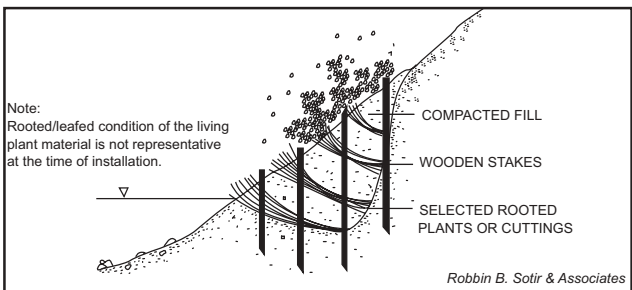

Figure 6. Illustration of Branchpacking

Table 1. Streambank Erosion Protection Measures Relative Costs and Complexity

Measure	Relative Cost	Relative Complexity
Live stake	Low	Simple
Joint planting	Low*	Simple*
Live fascine	Moderate	Moderate
Brushmattress	Moderate	Moderate to Complex
Live cribwall	High	Complex
Branchpacking	Moderate	Moderate to Complex
Conventional vegetation	Low to Moderate	Simple to Moderate
Conventional bank armoring (riprap)	Moderate to High	Moderate to Complex

*Assumes rock is in place.

MAINTENANCE

- Check banks after every high-water event, fixing gaps in the vegetative cover at once with structural materials or new plants, and mulching if necessary.
- Fresh cuttings from other plants may be used for repairs.
- When fertilizer is applied on the surface, it is best to apply about one-half at planting, one-fourth when new growth is about two inches tall, and one-fourth about six weeks later.

REFERENCES

- Mb Erosion Control Matting and Blankets
- Ds1 Disturbed Area Stabilization
(With mulching only)
- Ds2 Disturbed Area Stabilization
(With temporary seeding)
- Ds3 Disturbed Area Stabilization
(With permanent seeding)
- Ds4 Disturbed Area Stabilization
(With sodding)
- Guidelines for Streambank Restoration,
Georgia Soil and Water Conservation Commission

(This page left blank intentionally.)

DEFINITION

Substances used to anchor straw or hay mulch by causing the organic material to bind together.

PURPOSE

The purpose of tackifiers and binders is to prevent the movement of mulching material from the desired location. It also increases the performance of the mulching material, so that it can:

- Increase infiltration.
- Reduce wind and water erosion.
- Conserve moisture and prevent surface compaction or crusting.
- Control undesirable vegetation.
- Modify soil temperature.
- Increase biological activity in the soil.

SPECIFICATIONS

All organic mulching materials shall be anchored by tackifiers/binders or matting/netting. Tackifiers and binders are used to anchor wood cellulose, wood pulp fiber, and other mulch materials applied with hydroseeding equipment.

(This page left blank intentionally.)

MAJOR LAND RESOURCE AREAS (MLRAS) OF GEORGIA

- Mountain, Blue Ridge, and Ridges and Valley
- Southern Piedmont
- Southern Coastal Plain, Sand Hills, Black Lands, and Atlantic Coastal Flatwoods

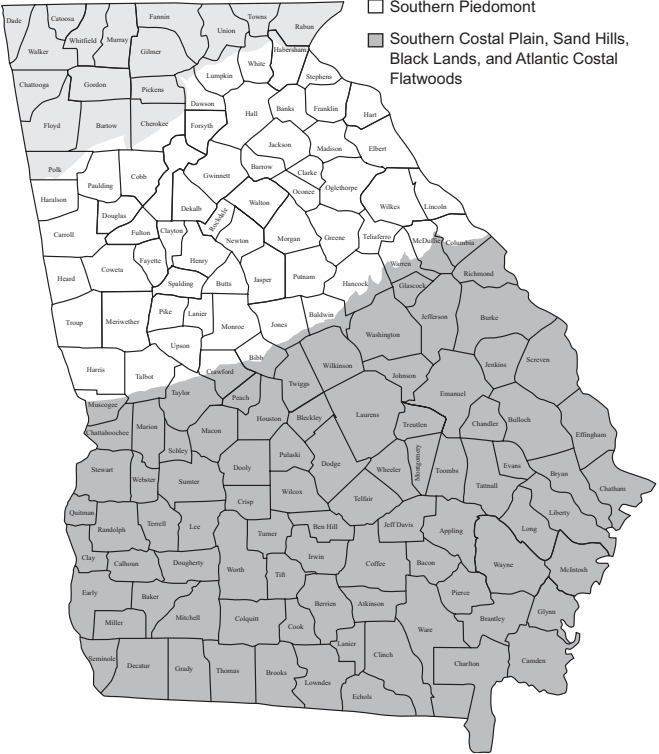

STRUCTURAL BEST MANAGEMENT PRACTICES

(Cd)	Check Dam	52
(Ch)	Channel Stabilization	54
(Co)	Construction Exit	56
(Cr)	Construction Road stabilization	58
(Dc)	Stream Diversion Channel	60
(Di)	Diversion	64
(Dn1)	Temporary Downdrain Structure	66
(Dn2)	Permanent Downdrain Structure	70
(Fr)	Filter Ring	72
(Ga)	Gabion	74
(Gr)	Grade Stabilization Structure	76
(Lv)	Level Spreader	78
(Rd)	Rock Filter Dam	80
(Re)	Retaining Wall	82
(Rt)	Retrofit	84
(Sd1)	Sediment Barrier	88
(Sd2)	Inlet Sediment Trap	94
(Sd3)	Temporary Sediment Basin	100
(Sr)	Temporary Stream Crossing	106
(St)	Storm Drain Outlet Protection	110
(Su)	Surface Roughening	114
(Tp)	Topsoiling	118
(Wt)	Vegetated Waterway or Stormwater Conveyance Channel	120

DEFINITION

A small temporary barrier constructed across a swale, drainage ditch, or area of concentrated flow.

**PURPOSE**

- Reduce velocity.
- Filter sediment.
- Stabilize grade.

INSTALLATION

- Install according to approved plan, if shown.
- Place in small, open channels, **not in live streams**.
- Construct center at least 9 inches lower than outer edges.
- Extend across entire width of ditch or swale.
- Make side slopes 2:1 or flatter.
- Toe of the upstream dam should be at the same elevation as the top of the downstream dam.
- Seed and mulch area beneath the dam after its removal.

Stone Check Dams (Cd-S)

- Drainage area not to exceed 2 acres.
- Constructed of graded size 2"-10" stone.
- 2 feet maximum dam height measured to center of check dam.
- Place a suitable geotextile between the rock and its soil base and abutments.

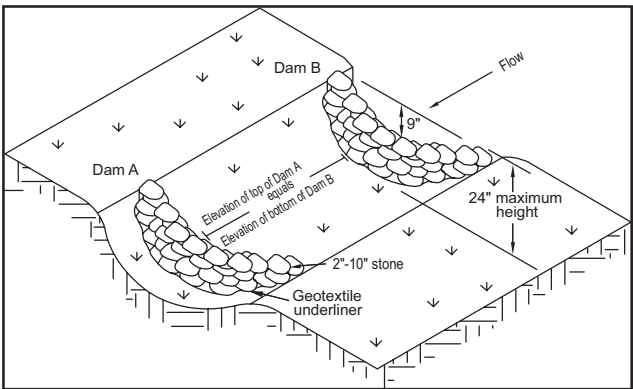

Figure 1. Stone Check Dam Installation Requirements

MAINTENANCE

- Periodic inspection and maintenance required.
- Remove sediment when it reaches a depth of one-half the original dam height.
- Remove at the completion of its useful life.

REFERENCES

- [Ds1] Disturbed Area Stabilization (With mulching only)
- [Ds2] Disturbed Area Stabilization (With temporary seeding)
- [Ds3] Disturbed Area Stabilization (With permanent seeding)
- [Ds4] Disturbed Area Stabilization (With sodding)

DEFINITION

Improving, constructing, or stabilizing an open channel or waterway.



PURPOSE

- Prevent erosion and sediment deposition.
- Provide adequate capacity for flood water, drainage, or other water management practices.

INSTALLATION

- Install according to approved plan, if shown.
- Drainage area not to exceed one square mile.
- Establish or install immediately after construction or as soon as weather permits.

Vegetative Lining (Ch-V)

- Permanent or temporary vegetation may be used.
- Install erosion control blankets, if required.

Rock Riprap Lining (Ch-Rp)

- Slopes should be 1.5:1 or less.
- Place a filter blanket, at least 6 inches thick, of sand, gravel, and/or geotextile material between the riprap and the base material.

Concrete Lining (Ch-C)

- For channels where velocities exceed 10 feet per second.

Grade Stabilization Structure

- Constructed of concrete, rock, masonry, steel, aluminum or treated wood.
- Provide adequate outlet for discharge.
- Do not compromise the environmental integrity of the area.
- Vegetate all disturbed areas immediately.

MAINTENANCE

Periodic inspection and maintenance required.

REFERENCES

- (Gr) Grade Stabilization Structure
- [Ds1] Disturbed Area Stabilization
(With mulching only)
- [Ds2] Disturbed Area Stabilization
(With temporary seeding)
- [Ds3] Disturbed Area Stabilization
(With permanent seeding)
- [Ds4] Disturbed Area Stabilization
(With sodding)

DEFINITION

A stone-stabilized pad located at any point where traffic will be leaving a construction site to a public right-of-way, street, alley, sidewalk, or parking area.

***PURPOSE***

Reduce or eliminate the transport of mud from the construction area.

INSTALLATION

- Install according to approved plan, if shown.
- Use 1.5"-3.5" stone.
- Minimum pad thickness of 6 inches.
- Minimum pad width of 20 feet.
- Minimum pad length of 50 feet.
- Excavate footprint 3 inches.
- If tire washing is required, route runoff from washing to an approved sediment trap or sediment basin.
- Install filter fabric under the entire pad.

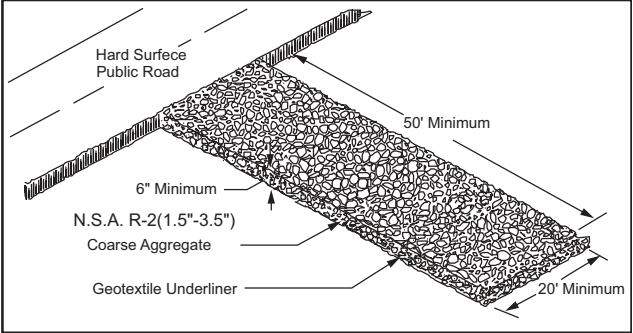

Figure 1. Crushed Stone Construction Exit Installation Requirements



Figure 2. Geotextile Underliner Under Gravel Pad

MAINTENANCE

- Periodically dress with 1.5"-3.5" stone.
- Maintain in a condition that will prevent tracking or flow of mud onto public rights-of way.
- Immediately remove mud and debris tracked or spilled onto roadways.

CONSTRUCTION ROAD STABILIZATION

DEFINITION

A travel way constructed as part of a construction plan including access roads, subdivision roads, parking areas, and other on-site vehicle transportation routes.



PURPOSE

To provide a fixed route of travel for construction traffic and to reduce erosion and subsequent regrading of permanent roadbeds between time of initial grading and final stabilization.

INSTALLATION

- Install according to approved plan.
- Temporary roads shall follow the contours of the natural terrain to minimize disturbance of drainage patterns.
- If a temporary road must cross a stream, the crossing must be designed, installed and maintained according to temporary stream crossing (Sr) specifications.

- Grades for temporary roads should not exceed 10 per cent except for short lengths with a maximum of 20 per cent for special uses.
- Temporary roadbeds shall be at least 14 feet wide for one-way traffic, 20 feet wide for two-way traffic, and 24 feet wide for trailer traffic.
- All cut and fills shall have side slopes at a maximum of 2:1 or 3:1 if mowing is planned.
- Drainage channels shall be designed to be on stable grades or protected with structures or linings for stability.
- Geotextile should be applied to the roadbed for additional stability according to the design manual specifications.
- A 6-inch layer of coarse aggregate shall be applied immediately after grading.

MAINTENANCE

Roads and parking areas may require a periodic top dressing of gravel to maintain the gravel depth at 6 inches. Vegetated areas should be checked periodically to ensure a good stand of vegetation is maintained. Remove any silt or other debris causing clogging of roadside

REFERENCES

- Sr Temporary Stream Crossing

STREAM DIVERSION CHANNEL

DEFINITION

A temporary channel constructed to convey flow around a construction site while a permanent structure is being constructed in the stream channel.

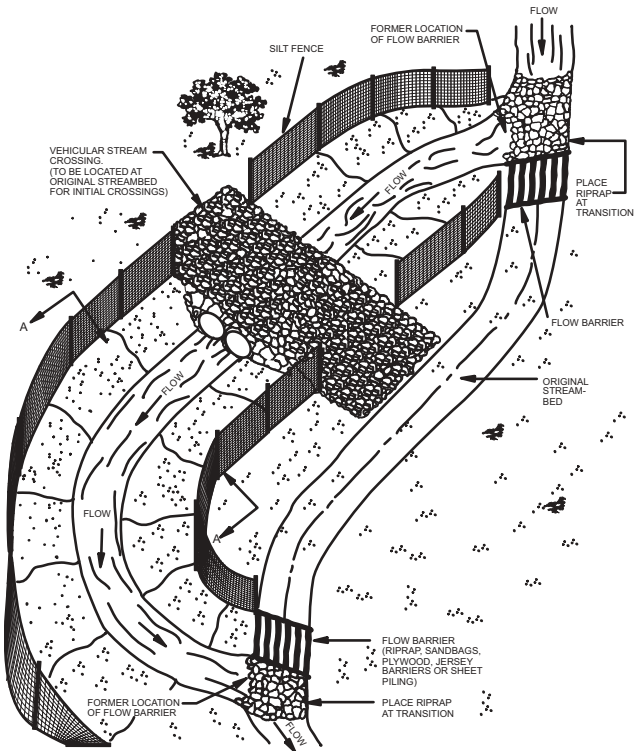

Figure 1. Stream Diversion Channel (Perspective View)

PURPOSE

To protect the streambed from erosion and allow work “in the dry”.

INSTALLATION

- Install according to approved plan.
- Drainage area not to exceed one square mile (640 acres).
- The bottom width of the stream diversion shall be a minimum of six feet or equal to the bottom width of the existing streambed, whichever is greater.
- Side slopes of the stream diversion channel shall be no steeper than 2:1.
- Depth and grade of the channel shall be sufficient to ensure continuous flow of water in the diversion.
- The channel shall be lined to prevent erosion of the channel and sedimentation in the stream. The lining is selected based upon the expected velocity of bankfull flow. The linings are as follows:
 - 1) Geotextile, polyethylene film or sod (Dc-A) for a velocity range of 0-2.5 fps.
 - 2) Geotextile alone (Dc-B) for a velocity range of 2.5-9.0 fps.
 - 3) Class I riprap and geotextile (Dc-C) for a velocity range of 9.0-13.0 fps.
- The channel shall be excavated, constructing plugs at both ends.
- Silt fence or berms shall be placed along the sides of the channel to prevent unfiltered runoff from entering the stream.
- The channel surface shall be smooth (to prevent tearing of the liner) and lined with the material specified in the plans.
- The plugs are removed when the liner installation is complete, removing the downstream plug first.

Dc

- As soon as construction in the streambed is complete, the diversion shall be replugged and backfilled.
- Upon removal of the lining, the stream shall immediately be restored and properly stabilized.
- All other appropriate agencies, including the COE, must be contacted to ensure compliance with other Laws.

MAINTENANCE

The stream diversion channel shall be inspected at the end of each day to make sure that the construction materials are positioned securely. This will ensure that the work area stays dry and that no construction materials float downstream. All repairs shall be made immediately.

REFERENCES

- Mb Erosion Control Matting and Blankets

(This page left blank intentionally.)

DEFINITION

A ridge of compacted soil, constructed above, across, or below a slope.

***PURPOSE***

- Reduce slope lengths.
- Intercept and divert storm runoff to a stable outlet at a non-erosive velocity.

INSTALLATION

- Install according to approved plan, if shown.
- Remove trees, brush, stumps and other objectionable material.
- Compact all fills.
- Channel cross-section should be trapezoidal or parabolic in shape.
- Side slopes should be 2:1 or flatter.
- Excavate narrow, deep channels on steep slopes and broad, shallow channels on gentle slopes.
- Adequate outlet must be present.

- Stabilize channel and outlet with vegetation (mulch required for all seeded or sprigged channels), riprap, or pavement.
- Dispose of and/or stabilize unneeded excavated material.

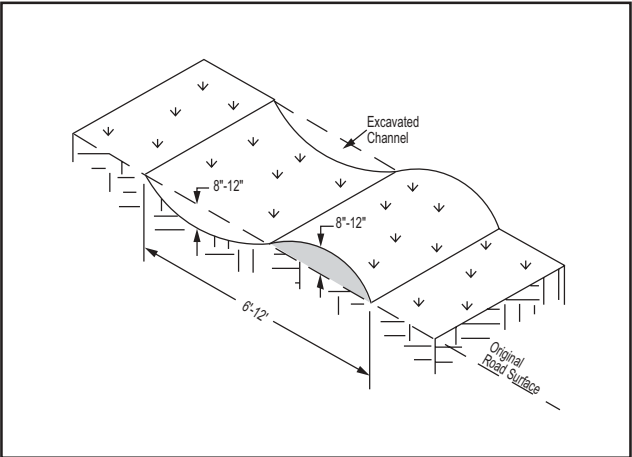

Figure 1. Typical Diversion Across Road

MAINTENANCE

Inspect frequently and after each rainfall and make necessary repairs.

REFERENCES

- **Ds1** Disturbed Area Stabilization (With mulching only)
- **Ds2** Disturbed Area Stabilization (With temporary seeding)
- **Ds3** Disturbed Area Stabilization (With permanent seeding)
- **Ds4** Disturbed Area Stabilization (With sodding)

TEMPORARY DOWN DRAIN STRUCTURE

DEFINITION

A temporary structure used to convey storm water down the face of cut or fill slopes.



PURPOSE

- Transport storm runoff from one elevation to another.
- Reduce slope erosion.

INSTALLATION

- Install according to approved plan, if shown.
- Install heavy-duty, flexible materials such as non-perforated, corrugated plastic pipe.

Table 1. Pipe Diameter for Temporary Downdrain

Maximum Drainage Area per Pipe (acres)	Pipe Diameter (inches)
0.3	10
0.5	12
1.0	18

- Place on undisturbed soil or well-compacted fill.
- Install tee, “L” or flared end section inlet at the top of the slope.
- Entrance sloped 1/2" per foot toward inlet.
- Compact a dike ridge no less than one foot above the top of the pipe.
- Anchor with hold-down grommets or stakes at intervals not to exceed 10 feet.
- Ensure connections are watertight.
- Extend pipe beyond the toe of the slope.
- Direct outlet uphill.
- Stabilize outlet with tee, riprap or other suitable material.
- Vegetate all disturbed areas immediately.
- See Figure 1.

MAINTENANCE

- Inspect drain and diversion after every rainfall and promptly make necessary repairs.
- Remove once the permanent water disposal system is installed.

REFERENCES

- (St) Storm Drain Outlet Protection

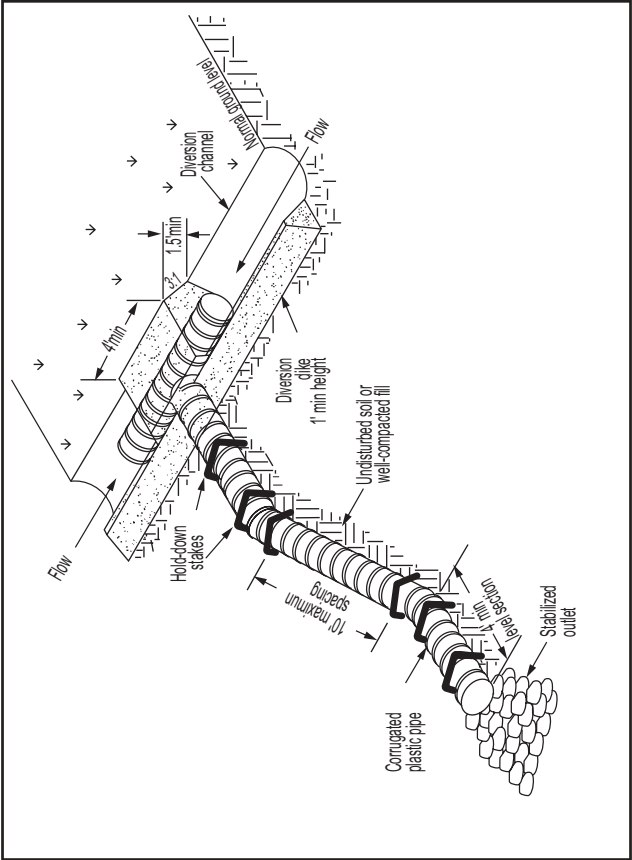

Figure 1. Temporary Downdrain and Inlet Detail

(This page left blank intentionally.)

PERMANENT DOWN DRAIN STRUCTURE

DEFINITION

A permanent structure to safely convey surface runoff from the top of a slope to the bottom of the slope.



PURPOSE

Minimize erosion due to concentrated storm runoff on cut or fill slopes.

INSTALLATION

- Install according to approved plan, if shown.
- Types of Structures
 - Paved flume: parabolic, rectangular, or trapezoidal cross section.
 - Pipe: steel, plastic, etc.
 - Sectional: a prefabricated sectional conduit of half-round or third-round pipe.
- Slopes must have sufficient grade to prevent sediment deposition.
- Stabilize outlet according to plans.
- Vegetate all disturbed areas immediately.

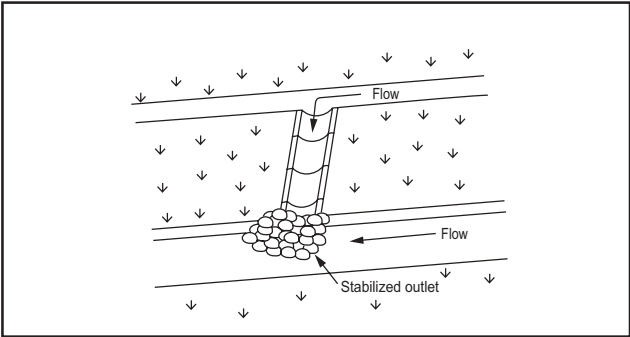

Figure 1. Typical Concrete Paved Flume

MAINTENANCE

Periodic inspection and maintenance required.

REFERENCES

- (St) Storm Drain Outlet Protection
- [Ds1] Disturbed Area Stabilization (With mulching only)
- [Ds2] Disturbed Area Stabilization (With temporary seeding)
- [Ds3] Disturbed Area Stabilization (With permanent seeding)
- [Ds4] Disturbed Area Stabilization (With sodding)

DEFINITION

A temporary stone barrier constructed at storm drain inlets and pond outlets.

PURPOSE

This structure reduces flow velocities, preventing the failure of other sediment control devices. It also prevents sediment from leaving the site or entering drainage systems, prior to permanent stabilization of the disturbed area.

INSTALLATION

- Filter rings shall be used in conjunction with other sediment control measures, except where other practices defined in this manual are not appropriate.
- The filter ring shall surround all sides of the structure receiving runoff from disturbed areas.
- The ring should be placed a minimum of 4 feet from the structure.
- If the ring is utilized above a retrofit structure, it should be a minimum of 8 to 10 feet from the retrofit.
- When utilized at inlets with diameters less than 12 inches, the filter ring shall be constructed of stone no smaller than 3-5 inches (15-30 lbs).
- When utilized at pipes with diameters greater than 12 inches, the filter ring shall be constructed of stone no smaller than 10-15 inches (50-100 lbs).
- The filter ring shall be constructed at a height no less than 2 feet above grade.

MAINTENANCE

The filter ring must be kept clear of trash and debris. This will require continuous monitoring and maintenance, which includes sediment removal when one-half full. These structures are temporary and should be removed when the land-disturbing project has been stabilized.

REFERENCES

- (Rt) Retrofit
- (Sd3) Temporary Sediment Basin
- (St) Storm Drain Outlet Protection

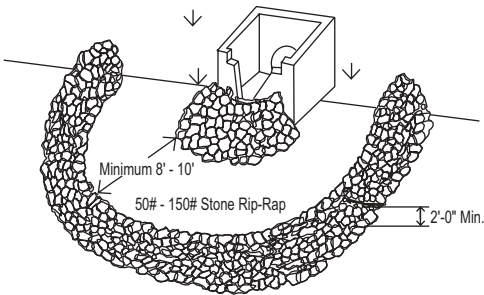

STONE FILTER RING

DEFINITION

Large, multi-celled, rock-filled wire mesh boxes used in channel revetments, retaining walls, abutments, check dams, etc.

***PURPOSE***

- Construction of erosion control structures.
- Stabilize steep or highly erosive slopes.

INSTALLATION

- Install according to approved plan, if shown.
- Foundations must be smooth and level.
- Only galvanized or PVC coated wire should be used.
- Set individual baskets into place, wire them together in courses, and fill with rock to form flexible monolithic building blocks.
- Rock should be durable and adequately sized (normally 4"-8") to be retained in the baskets.
- "Key" structure securely into foundations and abutment surfaces.

MAINTENANCE

Periodically inspect for signs of undercutting or excessive erosion at transition areas, and make necessary repairs immediately.

GRADE STABILIZATION STRUCTURE

DEFINITION

A structure to stabilize the grade in natural or artificial channels.



PURPOSE

- Stabilize the grade in natural or artificial channels.
- Prevent the formation or advancement of gullies.
- Reduce erosion and sediment pollution.

INSTALLATION

- Install according to approved plan, if shown.
- Construct with concrete, rock, masonry, steel, aluminum, or treated wood.
- Dewater excavations prior to filling.
- Construct minimum top width of 10 feet with side slopes of 3:1 or flatter on earthfill embankments that are constructed in 6" to 8" horizontal lifts.
- Compact fill to approximately 95 percent of standard density.
- Construct keyway 8 or more feet wide and 2 feet deep along centerline of the structure and embankment.

- Provide adequate outlet for discharge.
- Apply protective cover immediately after completion of the structure.
- Vegetate all disturbed areas immediately.
- All other appropriate agencies, including the COE, must be contacted to ensure compliance with other Laws.

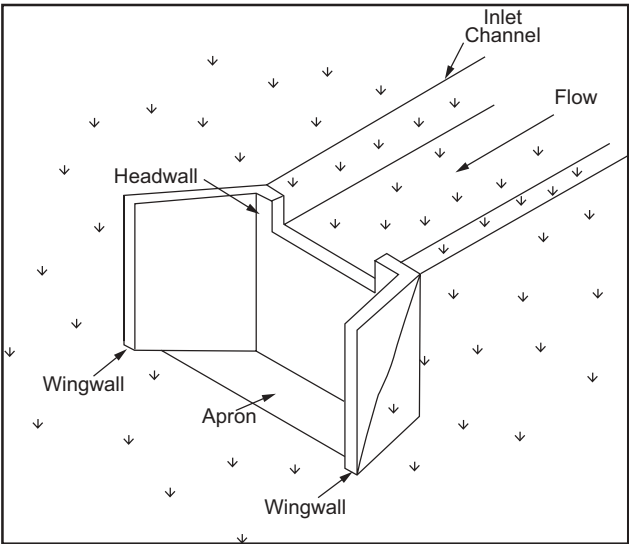

Figure 1. Typical Drop Spillway Structure

MAINTENANCE

Periodic inspection and maintenance required.

REFERENCES

- (St) Storm Drain Outlet Protection
- [Ds1] Disturbed Area Stabilization (With mulching only)
- [Ds2] Disturbed Area Stabilization (With temporary seeding)
- [Ds3] Disturbed Area Stabilization (With permanent seeding)
- [Ds4] Disturbed Area Stabilization (With sodding)

DEFINITION

An outlet device constructed at zero grade across the slope where concentrated runoff may be discharged at non-erosive velocities onto undisturbed areas stabilized by existing vegetation.

**PURPOSE**

- Minimize erosion.
- Convert concentrated storm runoff to sheet flow.
- Guide storm runoff to an undisturbed, vegetated area.

INSTALLATION

- Install according to approved plan, if shown.
- Grade the channel no greater than 1% for the last 15 feet of the dike or diversion.
- Construct on undisturbed soil that is stabilized with vegetation.
- Minimum width of 6 feet.
- Minimum, uniform depth of 6 inches as measured from the lip.
- Uniform depth across the entire length.

- Level lip constructed on zero percent grade.
- Discharge onto an undisturbed, stabilized area at zero grade.
- Provide a smooth outlet.
- Prevent water from concentrating below point of discharge.
- Vegetate all disturbed areas immediately.

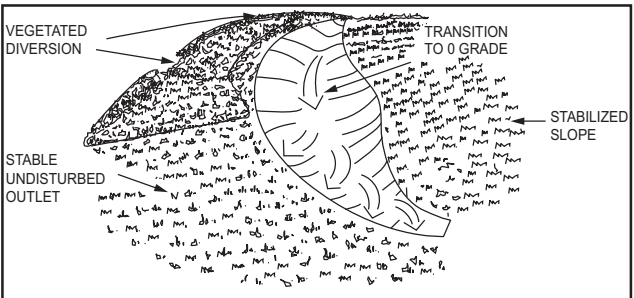

Figure 1. Level Spreader Installation Requirements

MAINTENANCE

Periodic inspection and maintenance is required.

REFERENCES

- **Ds1** Disturbed Area Stabilization (With mulching only)
- **Ds2** Disturbed Area Stabilization (With temporary seeding)
- **Ds3** Disturbed Area Stabilization (With permanent seeding)
- **Ds4** Disturbed Area Stabilization (With sodding)

DEFINITION

A temporary stone filter dam installed across small streams or drainageways.

***PURPOSE***

- Capture and filter sediment for removal when working in a stream or water body.
- Reduce velocity of water.

INSTALLATION

- Install according to approved plan, if shown.
- For use in small channels with drainage areas of 50 acres or less.
- Must be used in conjunction with other appropriate sediment control measures.
- Use below culvert installations, dam construction, or any project that may involve grading activity directly in a stream.
- Not intended to substantially impound water.
- Use at the upstream end of ponds or lakes.
- Edges should not be higher than the channel banks.

- Center should be at least 6 inches lower than the outer edges of the dam at the channel banks.
- Height should not exceed elevation of upstream property line.
- Side slopes should be 2:1 or flatter.
- Top width should be greater than 6 feet.
- Extend completely across the channel and securely tie into both channel banks.
- All other appropriate agencies, including the COE, must be contacted to ensure compliance with other Laws.

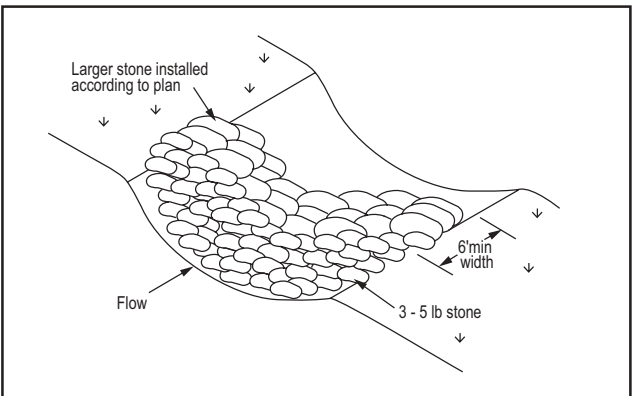

Figure 1. Rock Filter Dam Installation Requirements

MAINTENANCE

- Requires periodic inspection and maintenance.
- Sediment removed when it reaches one-half of the original dam height.
- Remove at the completion of its useful life.

DEFINITION

A constructed wall of one or more of the following: concrete masonry, reinforced concrete cribbing, treated timbers, steel pilings, gabions, stone drywall, rock riprap, etc.

**PURPOSE**

To assist in stabilizing cut or fill slopes where stability could only be obtained with the use of a wall.

INSTALLATION

Retaining walls require *specific designs* which are within the capabilities of a design engineer or a licensed architect. Close supervision is required to ensure proper installation.

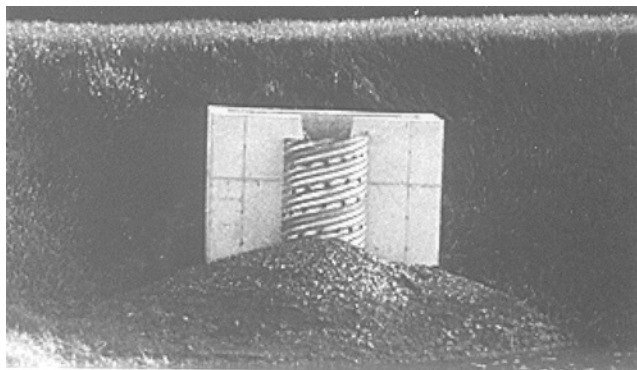

Figure 1. Typical Stone Retaining Wall

(This page left blank intentionally.)

DEFINITION

A device placed in front of an outlet structure to temporarily filter sediment.

**PURPOSE**

Allow stormwater detention basins to function as temporary sediment retention basins.

INSTALLATION

- Install according to approved plan, if shown.
- Prohibited in detention basins on live streams.
- Install on approximately 1/2 the height of the outlet structure.

Perforated Half-Round Pipe with Stone Filter

Rt-P

- Half-round pipe diameter should be 1.5 times the diameter of the principal pipe outlet or wider than the greatest width of the concrete weir.
- Attach to the outlet structure, but never use on exposed pipe end or winged headwall.
- Drainage area not to exceed 30 acres.
- See Figures 1 and 2.

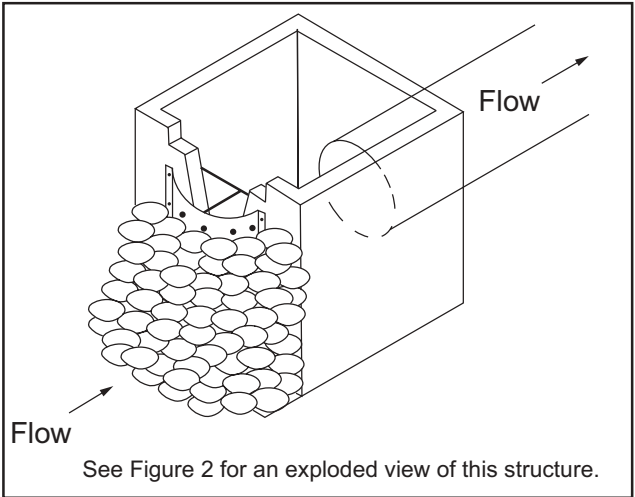

Figure 1. Perforated Half-Round Pipe Retrofit with Stone Filter.

Stone Filter Ring

- Use in conjunction with half-rounds or board dams.
- Minimum height of 2'.
- Minimum distance of 8' to 10' between retrofit and ring.
- Pipe with diameter larger than 12" requires 10"-15" stone, faced with smaller filter stone.

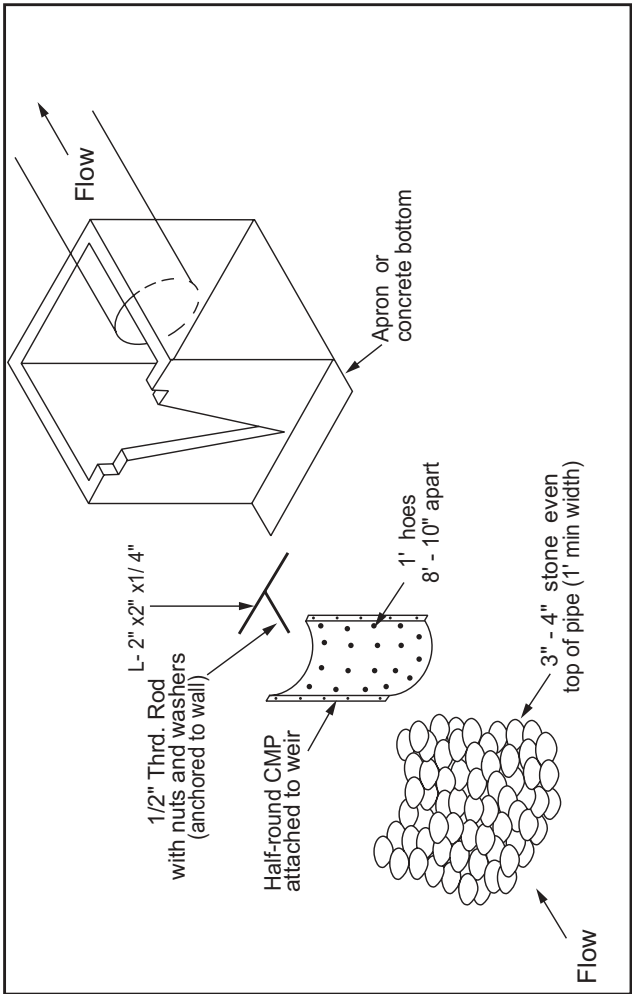

Figure 2. Perforated Half-Round Pipe Retrofit with Stone Filter Installation Requirements

Slotted Board Dam with Stone (Rt-B)

- Can be used with open pipe ends, winged headwalls, or concrete weir outlets.
- Install with 4x4" or larger posts with 0.5" to 1" spacing.
- Drainage area not to exceed 100 acres.
- Can excavate in front of the retrofitted outlet structure or raise the outlet structure to obtain required sediment storage.

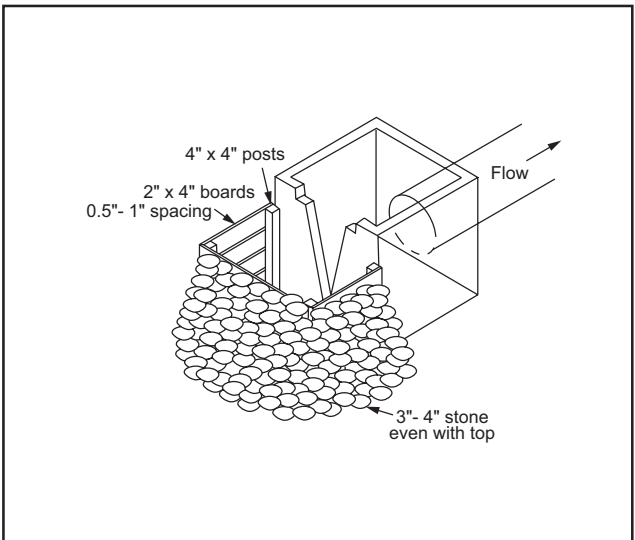

Figure 3. Slotted Board Dam Installation Requirements

MAINTENANCE

- Clean-out when one-third sediment storage capacity is lost. Indicate this elevation with a mark on the outlet structure or a post inserted in the pond.
- Remove all trash and debris.
- Remove retrofit and accumulated sediment when the project is completed.
- Stabilize all disturbed areas immediately with permanent vegetation.

DEFINITION

A temporary structure made of silt fence supported by steel or wood posts, sandbags, straw bales or other filtering material.

**PURPOSE**

- Slow the velocity of runoff and cause sediment deposition at the structure.
- Filter sediment from runoff.

INSTALLATION

- Install according to approved plan, if shown.
- Install along contours with ends pointing uphill.
- Do not place in waterways or areas of concentrated flow.

Sandbags (Sd1-S)

- Flow under or between bags should be minimal.
- Anchoring with steel rods may be required if height exceeds two bags.

Hay or Straw Bales (Sd1-Hb)

- Place in a single row, lengthwise, on the contour.
- Embed in the soil to a depth of 4 inches.
- Secure with stakes or bars driven through the bales or by other adequate means.
- Place in areas of low rate sheet flow.
- For use on projects with a duration of three months or less.

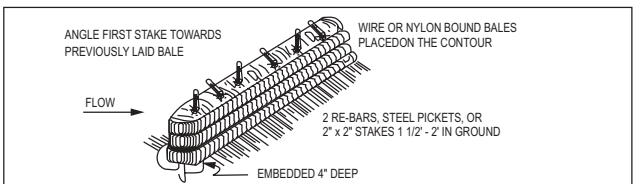

Figure 1. Straw Bale Barrier Installation Requirements

Brush (use during timber clearing operations)

(Sd1-Bb)

- Pile in a row along the perimeter of land-disturbing activities.
- Windrow on the contour as close as possible.
- Compaction may be required.
- Filter fabric may be placed on the construction side of the brush barrier for added filtering capacity. Lower edge must be entrenched 4 to 6 inches deep. The upper edge must be fastened to the brush barrier.

Silt Fence (Sd1-A) (Sd1-B) (Sd1-C)

- Install where sheet flow conditions exist.
- Drainage area is not to exceed 1/4 acre per 100 ft. of silt fence.

Sd1

- Verify fabric by inspection of fabric name printed every 100 ft. of silt fence.
- Start post installation at the center of the lowest point with remaining posts spaced according to Figures 2, 3, or 4.
- If non-erosive outlets are provided, slope length may be increased beyond that shown in Table 1.

Table 1. Criteria for Sediment Barrier Placement

Land Slope (percent)	Maximum Slope Length behind Fence (feet)
<2	100
2 to 5	75
5 to 10	50
10 to 20	25
>20	15

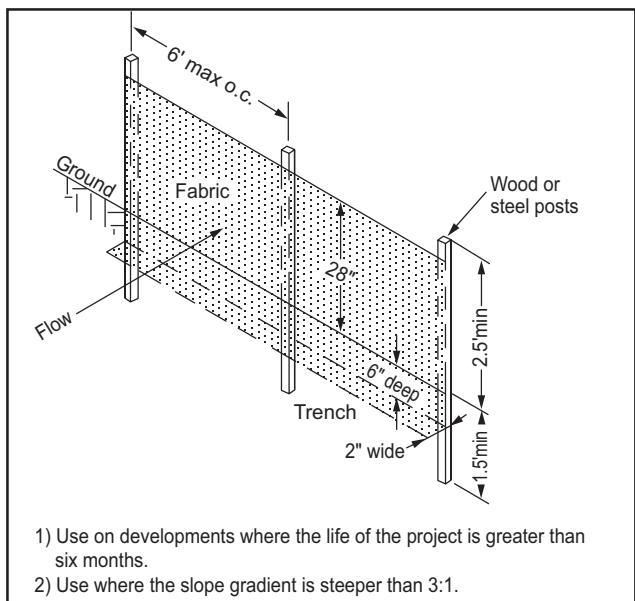

Figure 2. Type "A" Silt Fence (Sd1-A)

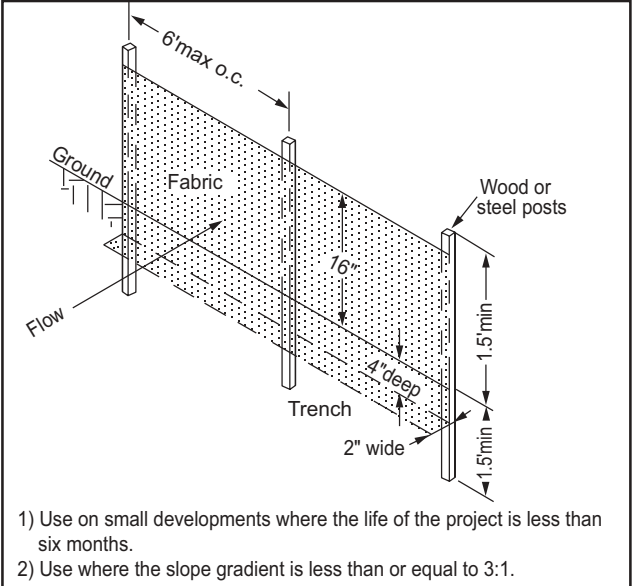

Figure 3. Type "B" Silt Fence (Sd1-b)

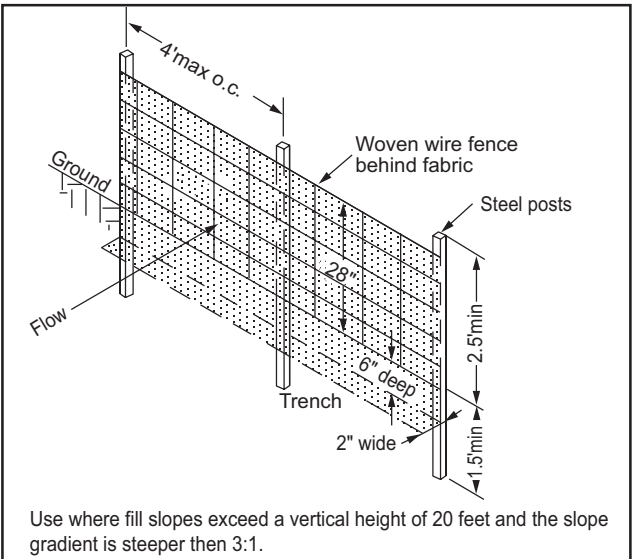

Figure 4. Type "C" (Sd1-C) Wire-Reinforced Silt Fence



Figure 5. Typical Type “C” Silt Fence

MAINTENANCE

- Inspect barriers at the end of each working day, or after each rain, and repair or clean as necessary.
- Remove sediment from barrier when one-half full.
- Dispose of sediment and stabilize it with vegetation.
- Replace filter fabric when deteriorated.
- Design life of a synthetic silt fence is approximately 6 months.
- Maintain until the project is vegetated or otherwise stabilized.
- Remove barriers and accumulated sediment and stabilize the exposed area when the project is stabilized.
- Approved silt fence fabrics are listed in the Georgia Department of Transportation Qualified Products List #36 (QPL-36).

(This page left blank intentionally.)

DEFINITION

A temporary sediment barrier placed around a storm drain drop inlet.

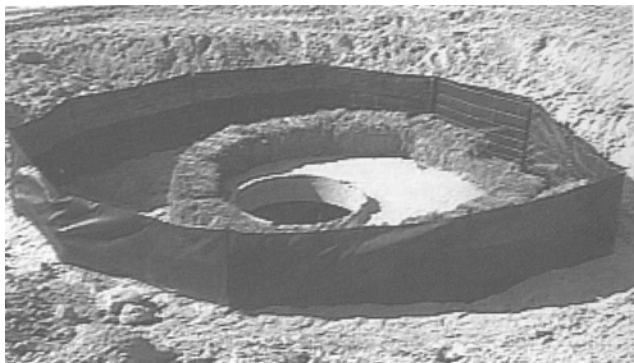
***PURPOSE***

Prevent sediment from entering storm drainage systems.

INSTALLATION

- Install according to approved plan, if shown.
- Do not install where vehicular traffic will be affected.
- Install at or around all storm drain drop inlets that receive runoff from disturbed areas.
- Construct on natural ground surface, excavated surface, or on machine compacted fill.

Excavated Sediment Traps

- Minimum of 1.5 feet of sediment storage in excavated sediment traps.
- Must be self-draining unless otherwise protected.

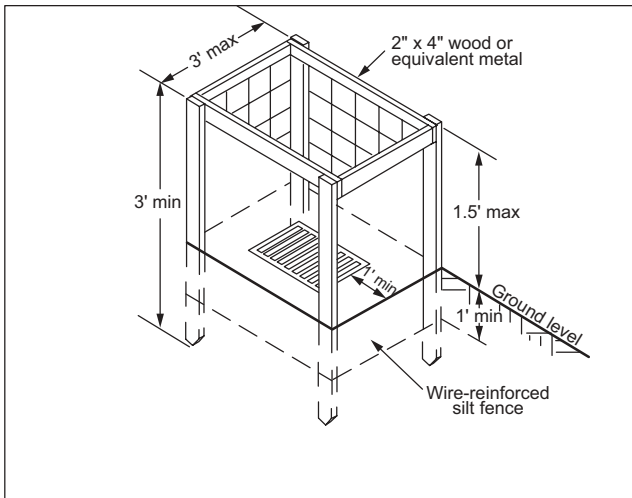

Figure 1. Fabric and supporting Frame for Inlet Protection (Sd2-F)

Block and Gravel Drop Inlet Protection

Sd2-Bg

- Excavate foundation at least 2 inches below the crest of the storm drain.
- On each side of the structure, place one block in the bottom row on its side to allow pool drainage.
- Place the bottom row of blocks against the edge of the storm drain.
- Add support by placing 2"x4" wood studs through block openings.
- Fit hardware cloth or wire mesh with 1/2 inch openings over all block openings to hold gravel in place.
- Place clean gravel 2 inches below the top of the block on a 2:1 or flatter slope and smooth it to an even grade. DOT #57 stone is recommended.

Sd2

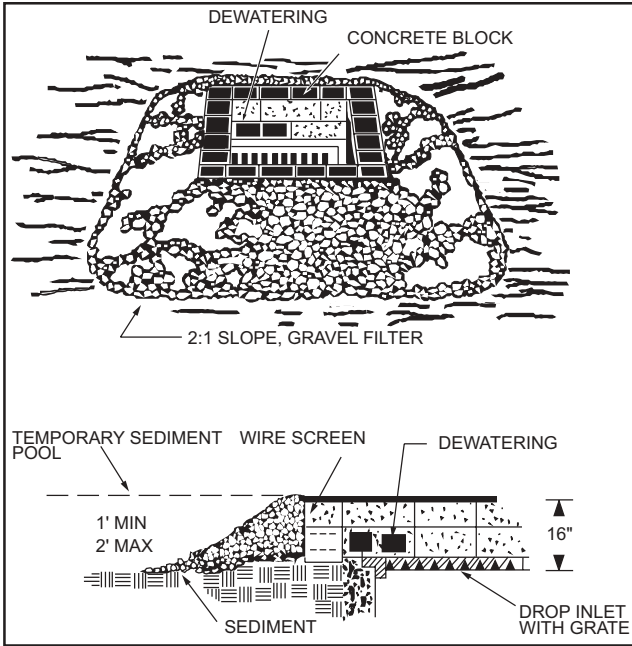

Figure 2. Block and Gravel Drop Inlet Protection Installation Requirements (Sd2-Bg)

Gravel Drop Inlet Protection (Gravel Donut)

Sd2-G

- 3:1 or flatter slope toward the inlet.
- Create a minimum 1-foot wide level stone area between the structure and the inlet to prevent gravel from entering the inlet.
- Place stone 3 inches in diameter, or larger, on the slope toward the inlet.
- Place 1/2" to 3/4" gravel on the slope away from the inlet at a minimum thickness of 1 foot.

Curb Inlet Filter (Pigs-in-a-Blanket") Sd2-P

- Install filter after asphalt pavement installation.
- Wrap 8" concrete blocks in filter fabric and span across catch basin inlet.
- Face openings in blocks outward.
- Leave a gap of approximately 4 inches between the curb and the filters to allow for overflow to prevent hazardous ponding.
- Install outlet protection below storm drain outlets.

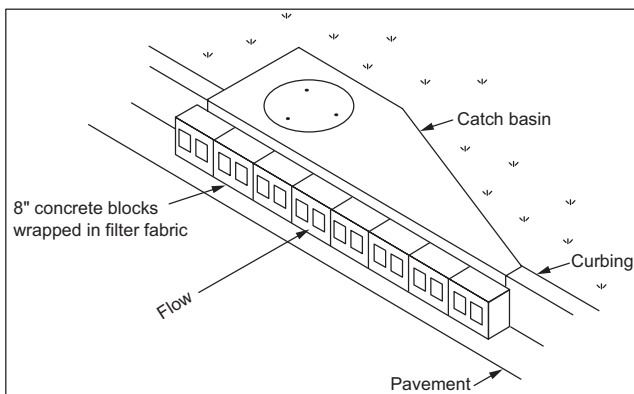

Figure 3. Curb Inlet Filter Installation Requirements (Sd2-P)



Figure 4. Alternative Inlet Sediment Trap

MAINTENANCE

- Inspect, clear, and/or repair trap at the end of each working day.
- Do not remove inlet protection and wash sediment into the storm drain.
- Remove sediment from the trap and stabilize it with vegetation.
- Remove all materials and any unstable soil once the contributing drainage area has been adequately stabilized.
- Appropriately stabilize all bare areas around the inlet.

REFERENCES

- Sd1 Sediment Barrier

(This page left blank intentionally.)

TEMPORARY SEDIMENT BASIN

DEFINITION

A basin created by excavation or the construction of a dam for sediment collection.



PURPOSE

- Detain runoff waters and trap sediment.
- Protect properties and drainageways below the basin from damage by excessive sedimentation and debris.

INSTALLATION

- Install according to approved plan, if shown.
- Length to width ratio shall be greater than 2:1, where length is the distance between the inlet and outlet.

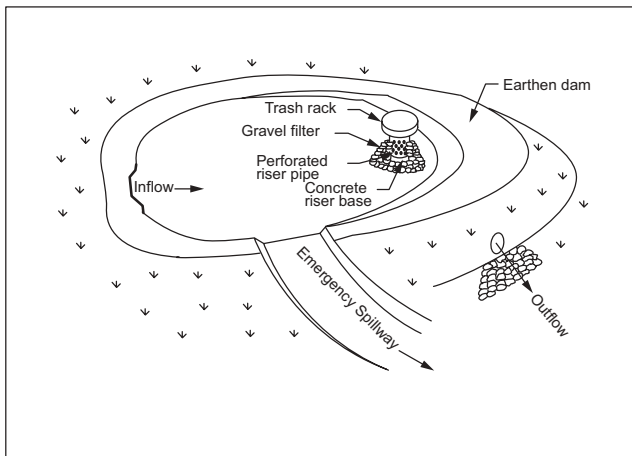

Figure 1. Components of a Typical Temporary Sediment Basin

Location

- Must never be placed in a live stream.
- Storm drains should discharge into the basin.
- Install on sites where (1) failure will not result in loss of life or interruption of use or service of public utilities and (2) the drainage area does not exceed 150 acres.

Principal Spillway

- Join vertical pipe or box type riser to a pipe that extends through the embankment and exits beyond the downstream toe of the fill.
- Perforate lower half of riser with 1/2 inch holes spaced approximately 3 inches, and cover with two feet of 1/2 to 3/4 inch aggregate.
- Install pipe with a minimum diameter of 8 inches.
- Equip with a trash rack and anti-vortex device.

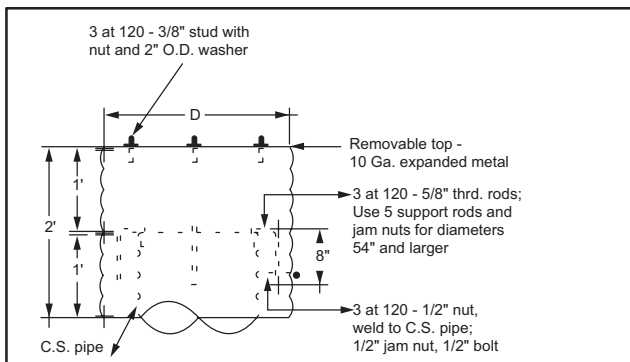

Figure 2. Typical Sediment Basin Trash Rack

- Attach riser to the base with a watertight connection. Embed riser 9 inches into an 18" thick concrete base.
- The riser and all pipe connections shall be completely watertight.

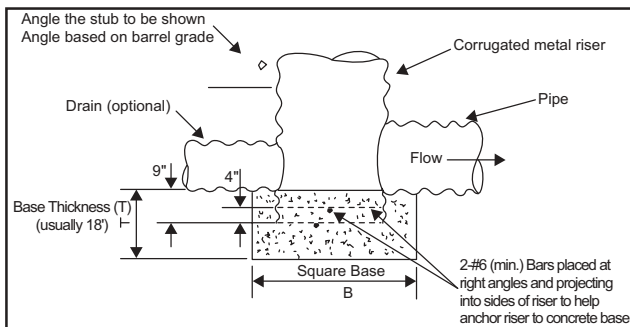

Figure 3. Concrete Riser Base Detail

Emergency Spillway

- Constructed in undisturbed ground (not fill).
- Excavate a trapezoidal channel with minimum bottom width of 8 feet.
- Stabilize with vegetation, riprap, asphalt, or concrete.

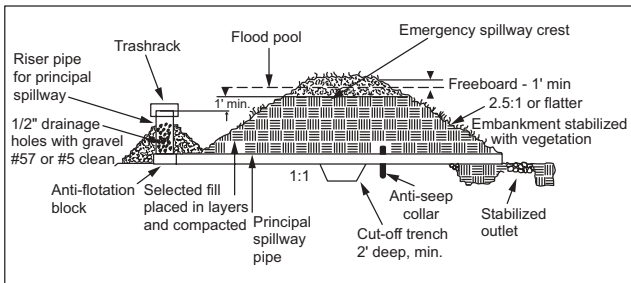

Figure 4. Section Through Embankment and Typical Features

Table 1. Sediment Basin Dam Width Requirements

Fill Height	Minimum Top Width
Less than 10 feet	8.0 feet
10 to 15 feet	10.0 feet

Entrance of Runoff into Basin

- Install dikes, swales, or other water control devices to direct runoff into the basin.
- Locate points of entry as far away from the riser as possible.
- Stabilize with permanent vegetation immediately following construction.

MAINTENANCE

- Remove sediment when storage volume has been reduced by one-third.
- Dispose and stabilize sediment beyond the reach of the pond.
- Do not deposit sediment downstream from the embankment, adjacent to a stream or floodplain.

Sd3

- Indicate clean-out elevation with a mark on the riser or by a marked post near the riser.
- Do not remove basin until the sediment-producing area is permanently stabilized.

REFERENCES

- **St** Storm Drain Outlet Protection
- **Ds1** Disturbed Area Stabilization
(With mulching only)
- **Ds2** Disturbed Area Stabilization
(With temporary seeding)
- **Ds3** Disturbed Area Stabilization
(With permanent seeding)
- **Ds4** Disturbed Area Stabilization
(With sodding)

(This page left blank intentionally.)

Sr

TEMPORARY STREAM CROSSING

DEFINITION

A temporary structure installed across a flowing stream or watercourse for use by construction equipment.



PURPOSE

Protect streams from damage and erosion.

INSTALLATION

- Install according to approved plan, if shown.
- Includes bridges (Sr-B), round pipes or pipe arches (Sr-C).
- Drainage area not to exceed one square mile.
- Minimize clearing and excavation of the streambed and banks.
- Cross very small streams with armored, protected fords, such as rock riprap.
- Elevate crossing to reduce the possibility of washout from a 25-year peak discharge.
- Convey full bank flow without appreciably altering or restricting stream flow habits.

- Washout protection may include elevation of bridges above adjacent flood plain lands, crowning of fills over pipes, or the use of diversions, dikes or island type structures.

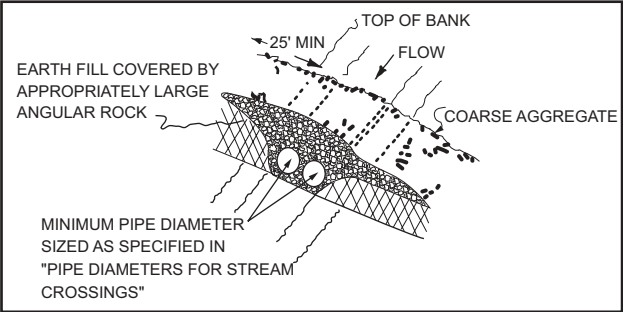

Figure 1. Temporary Stream Crossing Installation Requirements

Table 1. Pipe Diameters for Stream Crossings (inches)

Drainage Area (acres)	Average Slope of Watershed			
	1%	4%	8%	16%
1-25	24	24	30	30
26-50	24	30	36	36
51-100	30	36	42	48
101-150	30	42	48	48
151-200	36	42	48	54
201-250	36	48	54	54
251-300	36	48	54	60
301-350	42	48	60	60
351-400	42	54	60	60
401-450	42	54	60	72
451-500	42	54	60	72
501-550	48	60	60	72
551-600	48	60	60	72
601-640	48	60	72	72

Sr

- Remove when no longer necessary for project construction.
- Properly reshape the stream and its banks to the original cross-section after removal of the crossing.
- Stabilize denuded areas with appropriate vegetation.
- All other appropriate agencies, including the COE, must be contacted to ensure compliance with other Laws.

MAINTENANCE

- Inspect structure after every rainfall and at least once a week.
- Repair all damages immediately.

REFERENCES

- **Ds1** Disturbed Area Stabilization
(With mulching only)
- **Ds2** Disturbed Area Stabilization
(With temporary seeding)
- **Ds3** Disturbed Area Stabilization
(With permanent seeding)
- **Ds4** Disturbed Area Stabilization
(With sodding)

(This page left blank intentionally.)

STORM DRAIN OUTLET PROTECTION

DEFINITION

Paved and/or riprapped channel sections placed below storm drain outlets.



PURPOSE

- Reduce the velocity of flow from storm drain outlets.
- Reduce erosion of receiving channels.
- Stabilize grades.

INSTALLATION

- Install according to approved plan, if shown.
- Place a filter blanket or filter fabric between riprap and soil foundation.
- Install a graded gravel layer if geotextile is not used.
- Line with riprap, grouted riprap, or concrete. Use field or quarry stone with minimum diameter of 6 inches for riprap.
- Minimum apron thickness should be 1.5 times the maximum stone diameter.
- Extend apron length to at least six times the outlet pipe diameter.

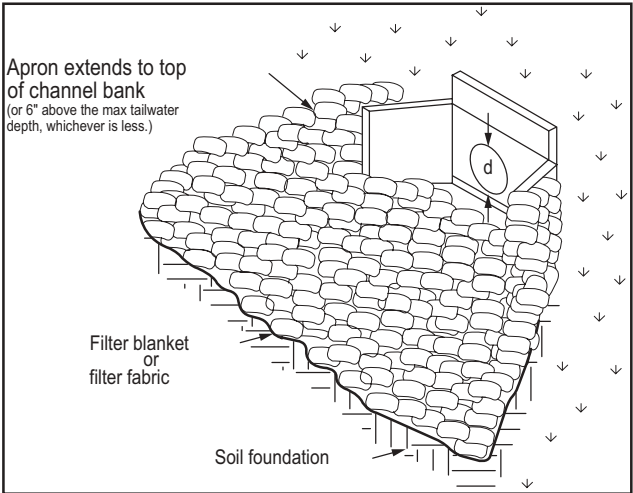

Figure 1. Outlet Protection for a Well-Defined Channel

Apron Width for a Well-Defined Channel

- Side slopes of the channel no steeper than 2:1.
- Apron extends across the channel bottom.
- Apron extends up the channel banks to an elevation one foot to the top of the bank.

Apron Width for a Flat Area

- Upstream width three times the diameter of the outlet pipe.
- Downstream width three times the diameter of the outlet pipe plus the length of the apron.
- Construct apron at zero grade with no overfall at the end.
- Conform to bottom grade of receiving channel.

- Locate to prevent bends in horizontal alignment.
- Place necessary curves in the upper section of the apron.
- Vegetate all disturbed areas immediately.

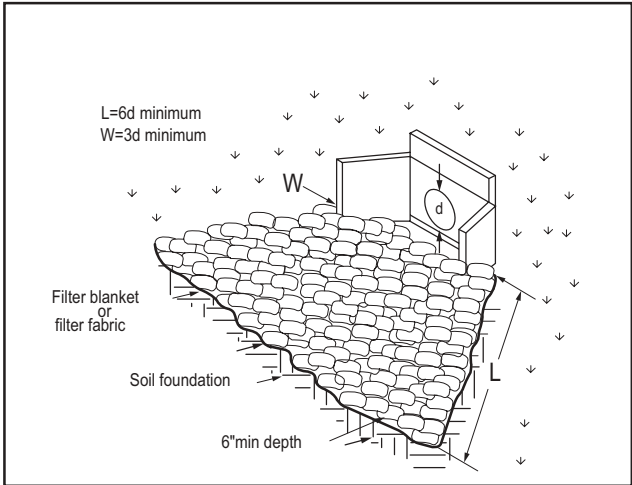

Figure 2. Outlet Protection for a Flat Area

MAINTENANCE

- Inspect after heavy rains for erosion and dislodged stones.
- Make all repairs immediately.

(This page left blank intentionally.)

DEFINITION

Providing a rough soil surface on the contour.

**PURPOSE**

- Aid in establishment of vegetative cover with seed.
- Reduce runoff velocity and increase infiltration.
- Reduce erosion and provide for sediment trapping.

INSTALLATION

- Apply according to approved plan, if shown.
- Not required on slopes with a stable rock face.
- Stair-step, groove, furrow, or track slopes that are to be vegetated.
- Lightly roughen and loosen soil to a depth of 2"-4" on slopes 3:1 or flatter.
- Slopes requiring mowing shall not be steeper than 3:1.
- Groove or maintain roughness of fill slopes steeper than 3:1.
- Stair-step or groove cut slopes steeper than 3:1.

Stair-Step Grading

- Particularly good for slopes with soft rock.
- Vertical cut distance to horizontal distance shall be less than 1:1. Horizontal portion of the “step” shall slope toward the vertical wall.
- Individual vertical cuts are not to exceed 30 inches on soft materials and not more than 40 inches in rocky materials.

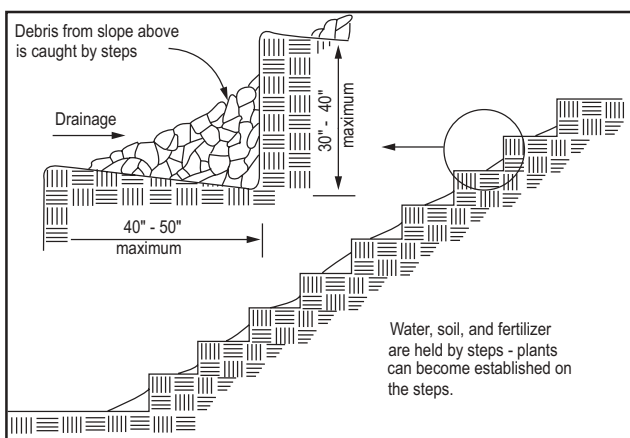

Figure 1. Stair-Stepping Cut Slopes



Figure 2. Typical Stair-Step Grading

Grooving

- Use discs, tillers, spring harrows, or the teeth on a front-end loader.
- On unmowed slopes, minimum groove depth of 3 inches and maximum groove spacing of 15 inches.
- On mowed slopes, minimum depth of one inch and maximum groove spacing of 12 inches.

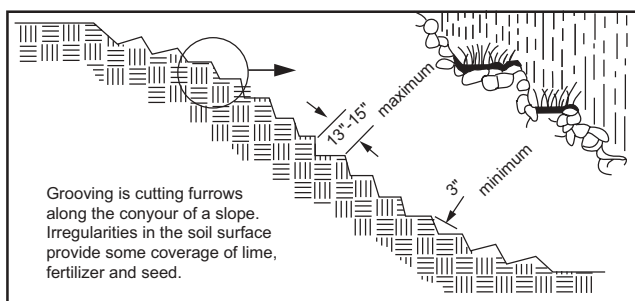

Figure 3. Grooving Slopes

Tracking

- Not recommended unless no alternatives are available.
- Minimize machine passes to minimize compaction.

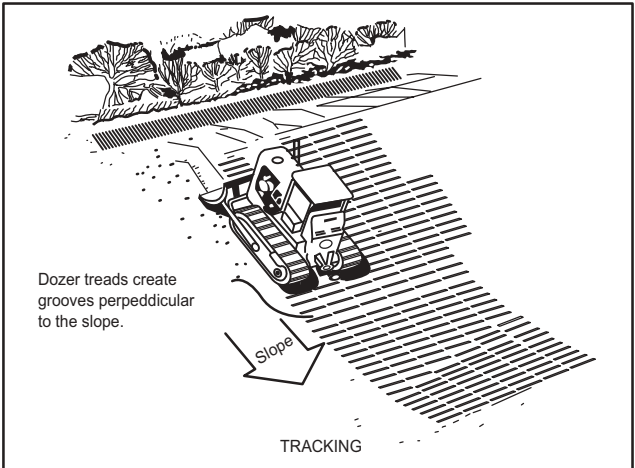

Figure 4. Roughening with Tracked Machinery

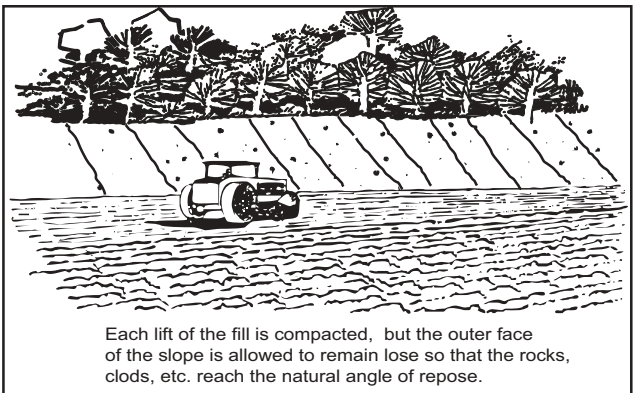

Figure 5. Fill Slope Treatment

- Seed and mulch roughened areas as soon as possible.

DEFINITION

Stripping-off the fertile top soil, storing it, then spreading it over the disturbed area after construction is completed.

**PURPOSE**

Provide a suitable soil medium for vegetative growth on low fertility areas.

SPECIFICATIONS

- Apply according to approved plan, if shown.
- Recommended for sites with slopes 2:1 or flatter where:
 - the texture of the exposed subsoil or parent material is not suitable to produce adequate vegetative growth,
 - the root zone is too shallow, or
 - the soil to be vegetated contains material toxic to plant growth.
- Topsoil should be friable and loamy, free of debris, objectionable weed and stones, and contain no toxic substance that may be harmful to plant growth.

- Stripping depth of 4 to 6 inches is common and should be confined to the immediate construction area.
- Stockpiles may be vegetated and should not obstruct natural drainage or cause off-site environmental damage.
- If subsoil is composed of heavy clays, lime shall be spread at the rate of 100 pounds per 1,000 square feet.
- Subsoil should be loosened by discing or scarifying to a minimum depth of 3 inches to permit bonding of the topsoil to the subsoil. Tracking by a bulldozer is also adequate.
- Topsoil should be applied at a uniform depth of 5 inches (unsettled), but may be adjusted at the discretion of the engineer or landscape architect.

Table 1. Cubic Yards of Topsoil Required for Application to Various Depths

Depth (inches)	Per 1,000 Square Feet	Per Acre
1	3.1	134
2	6.2	268
3	9.3	403
4	12.4	537
5	15.5	672
6	18.6	806

Wt

VEGETATED WATERWAY OR STORMWATER CONVEYANCE CHANNEL

DEFINITION

A waterway that is shaped or graded to required dimensions and stabilized with vegetation.



PURPOSE

- Dispose of stormwater runoff.
- Prevent erosion.
- Reduce sedimentation.

INSTALLATION

- Install according to approved plan, if shown.
- Remove all woody growth, obstructions and other objectionable material.
- Waterway cross-section may be parabolic or trapezoidal in shape.
- Maximum permissible velocity within a vegetated channel is approximately 5 feet per second without geosynthetic material.

Table 1. Permissible Velocities for Vegetated and Rock-Lined Waterways

Vegetative Cover	Maximum Permissible Velocity (fps)
Bermuda	5
Bahia	4
Tall Fescue	4
Sericea Lespedeza Weeping Lovegrass	3
Stone center	Design required

- Maximum bottom width of 50 feet unless multiple or divided waterways or other means are provided to control meandering of low flows within this limit.

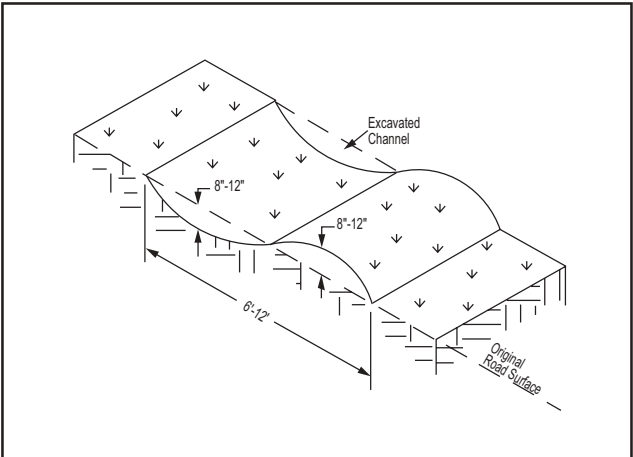

Figure 1. Typical Vegetated Waterway or Stormwater Conveyance Channel

- Tile or other subsurface drainage measure shall be provided for sites having high water tables or seepage problems. Where there is base flow, a stone center or lined channel may be required.

Wt

- Disturbed areas must be stabilized with vegetation immediately following construction.
- Mulching is required for all seeded or sprigged channels.
- Erosion control fabrics which are designed to protect seed and slopes during the establishment of vegetation shall be used.
- If conditions permit, water should be temporarily diverted from the channel, or otherwise disposed of, during the establishment of vegetation.

REFERENCES

- **Ds1** Disturbed Area Stabilization
(With mulching only)
- **Ds2** Disturbed Area Stabilization
(With temporary seeding)
- **Ds3** Disturbed Area Stabilization
(With permanent seeding)
- **Ds4** Disturbed Area Stabilization
(With sodding)

(This page left blank intentionally.)

O.C.G.A. 12-7-1 The Erosion and Sedimentation Act of 1975 as Amended

HISTORY

Georgia's Erosion and Sedimentation Act was passed in 1975 and became effective in 1977. It has been amended several times; in 1980, 1985, 1989, 1994, 1995 and 2000. The 1994 and 1995 amendments were significant in that the emphasis is now on Best Management Practices (BMPs) instead of water quality.

AGENCIES

This law specifically defines the duties of four separate and distinct agencies:

1. Local Issuing Authority (LIA).
2. The Environmental Protection Division (EPD) of the Department of Natural Resources (DNR).
3. The Soil and Water Conservation District (SWCD).
4. The State Soil and Water Conservation Commission (SSWCC).

Unnamed, but critically important to the program, is the Natural Resource Conservation Service (NRCS) of the US Department of Agriculture (USDA).

CERTIFICATION AS A LOCAL ISSUING AUTHORITY

City and County governments may become LIAs by adopting ordinances and enforcing provisions of the Law for specific land-disturbing activities (LDA). By becoming a LIA, the local government may also issue LDA permits. Otherwise, the EPD will have permitting, inspection and enforcement authority within the local government's jurisdiction. Most metro governments have elected to become issuing authorities along with over 80 percent of the counties. Among smaller towns and cities, over 40 percent are issuing authorities. In fact, over 90 percent of Georgia's population resides where local governments have that responsibility.

LAND-DISTURBING ACTIVITIES

The Law defines a land-disturbing activity as:

“Any land change which may result in soil erosion from water or wind and the movement of sediments into State Water or onto lands within the State including, but not limited to clearing, dredging, grading, excavating, transporting, and filling.”

EXEMPTED LAND-DISTURBING ACTIVITIES

The Law contains certain exemptions. Permits for land-disturbing activities are not required for the following:

1. Surface mining.
2. Granite quarrying.
3. Minor land-disturbing activities such as home gardens, home landscaping, etc.

4. Construction of single-family residences for or by the owner.
5. Agricultural Practices.
6. Forestry Practices.
7. Projects of the Natural Resources Conservation Service (NRCS).
8. Projects of 1.1 acre or less (if not within 200' of State Waters).
9. Construction or maintenance projects by the Department of Transportation, the Georgia Highway Authority, or Georgia Tollway Authority and road construction and maintenance projects by counties and cities.
10. Any LDA by an EMC or municipal electrical system or public utility regulated by the Public Service Commission.
11. Public Water System Reservoirs

Although permits are not required, exemptions 4, 8, 9, 10 and 11 must meet certain minimum requirements of the Law.

MINIMUM REQUIREMENTS

The minimum requirements specified in the Law mandate that Best Management Practices (BMPs) be designed, installed and maintained in accordance with 16 sound conservation and engineering principals and accommodate up to and including a 25-year 24-hour rainfall event.

BMPs are vegetative measures and structural practices that, when properly applied, will provide effective erosion and sedimentation control for all rainfall events. Some of the vegetative measures are temporary and permanent plants, mulches, and undisturbed buffers.

There are many structural practices including diversions, sediment barriers and basins, waterways, etc. Properly designed, installed and maintained BMPs constitute a total defense against punitive actions by the EPD and the Local Issuing Authority. Should BMPs fail under less than the 25-year 24-hour rainfall event, then land-disturbers are subject to penalties of up to \$2,500 per day by the Issuing Authority and up to \$50,000-100,000 per day for water quality violations under a different law, the Georgia Water Quality Control Act. The storm water from a construction site should not increase the turbidity of the receiving waters by more than 25 Nephelometric Turbidity Units (NTUs) on warm water streams or more than 10 NTUs on streams classified as “trout streams.”

CONSERVATION AND ENGINEERING PRINCIPALS

The Law requires that BMPs conform to the criteria contained in the “big brother” of this Field Manual, The Manual for Erosion and Sediment Control in Georgia, which is published by the Conservation Commission.

Additionally, the Law requires that BMPs conform to the following principals:

1. LDAs shall be conducted so as to minimize erosion.
2. Cut and fill operations must be kept to a minimum.
3. Development plans must conform to topography and soil type, so as to create the lowest practicable erosion potential.
4. Whenever feasible, natural vegetation shall be retained, protected and supplemented.

5. The disturbed area and the duration of exposure to erosive elements shall be kept to a practicable minimum.
6. Disturbed soil shall be stabilized as quickly as practicable.
7. Temporary vegetation or mulching shall be employed to protect exposed critical areas during development.
8. Permanent vegetation and structural erosion control measures must be installed as soon as practicable.
9. To the extent necessary, sediment in runoff water must be trapped by the use of debris basins, sediment basins, silt traps, or similar measures until the disturbed area is stabilized. A disturbed area is stabilized when it is brought to a condition of continuous compliance with the requirements of the Law.
10. Adequate provisions must be provided to minimize erosion damage to cut and fill slopes.
11. Cuts and fills may not endanger adjoining property.
12. Fills may not encroach upon natural watercourses or constructed channels so as to adversely affect other property owners.
13. Grading equipment must cross flowing streams using bridges or culverts, except when they are not feasible; provided, in any case, that such crossing must be kept to a minimum.
14. LDA plans for E&SC shall include BMPs for the treatment or control of any sediment sources. They must also show adequate BMPs to retain sediments on site or preclude sedimentation of adjacent

waters beyond the levels specified in section 12-7-6 (a) (2).

15. Except as provided in paragraph 16, LDAs shall not be conducted within 25 feet of the banks of any state waters, as measured horizontally from the point where vegetation has been wrested by normal stream flow or wave action, except where the Director of EPD allows a variance that is at least as protective of natural resources and the environment, or where a drainage structure or a roadway drainage structure must be constructed. Adequate erosion control measures must be incorporated in the project plans and implemented on site. Buffers of at least 25 feet established pursuant to provisions of the "Georgia Water Quality Control Act" shall remain in force unless a variance is granted by the Director. The following requirements shall apply to any such buffer:
 - A. No LDAs shall be conducted within a buffer and a buffer shall remain undisturbed until all LDAs on the site are completed. Once the final stabilization of the site is achieved a buffer may be trimmed or thinned as long as long as the natural canopy is left in sufficient quantity. For single family construction, thinning or trimming of the buffer is allowed as long as the natural canopy is left in sufficient quantity.
 - B. The granting or denial of a variance request by the Director is based on the specific criteria of the rules adopted by the Board.
16. LDAs shall not be conducted within 50 horizontal feet as measured from the point where vegetation has been wrested by

normal stream flow or wave action of any state waters classified as “trout streams” pursuant to the “Georgia Water Quality Control Act” except where a roadway Drainage structure must be constructed, provided that streams classified as trout streams which discharge an average annual flow of 25 gallons per minute or less may be piped by the landowner. See above sections A and B of paragraphs for buffer requirements.

PLANS AND PERMITS

Before a permit on non-exempt land-disturbing activities can be obtained, an application and Erosion and Sediment Control plan must be submitted to the Issuing Authority. The Issuing Authority must forward the plan to the local Soil and Water Conservation District for approval unless they have entered a Memorandum of Agreement with the local Soil and Water Conservation District.

The Districts usually call on the State Soil and Water Conservation Commission or Natural Resources Conservation Service for technical assistance in plan reviews. The Law requires that a permit be issued or denied within 45 days after a complete application and plan are submitted.

MEMORANDUM OF AGREEMENT

A Local Issuing Authority can bypass the District plan review process by demonstrating that it has an effective program, has trained personnel and the capability to review plans. It can then petition the local SWCD to enter into a Memorandum of Agreement (MOA). Most of Georgia’s most populated counties and cities have elected to go this route.

The National Pollutant Discharge Elimination System (NPDES) Permit

A related Federal and State program also regulates land disturbance activities (LDAs). The Federal Clean Water Act and the Georgia Water Quality Control Act require the operator of an LDA to obtain a National Pollutant Discharge Elimination System (NPDES) Permit. This NPDES Permit regulates the discharge of storm water from LDAs of five (5) acres or more, and smaller parcels within developments of five (5) acres or more. As is the case with LDA permits issued pursuant to the Georgia Erosion and Sedimentation Act, the NPDES Permit requires that Best Management Practices (BMPs) be employed. The BMPs are described in this Manual. Further information regarding the NPDES Permit can be obtained from the Environmental Protection Division of the Georgia Department of Natural Resources.

Construction Checklist of “BMPs” And Minimum Requirements

Project Name: File No. _____

Inspection Date: _____ Time: _____ Inspected by: _____

Stage of Construction

___ Pre-Construction Phase

___ Construction Phase

___ Building Phase

___ Final Stabilization

Cd Check Dam		
Minimum Requirement	Passed	Failed
CENTER: 9 inches lower than outer edges.		
SIDE SLOPES: 2.1 or flatter		
SPACING: Toe of upstream dam is at same elevation as the top of the downstream dam.		
GEOTEXTILE: Placed between the rock and its soil foundation.		
MAINTENANCE: Sediment removed when depth reaches 1/2 the original dam height. Dam removed and area stabilized when useful life has expired.		

Ch Channel Stabilization		
Minimum Requirement	Passed	Failed
INSTALLATION: Channel lining installed immediately after grading and vegetate all bare areas.		
RIPRAP LINING: Graded to 1.5:1 or less. A filter blanket, at least 6" thick, of sand, gravel, and/or geotextile material should be between soil and riprap.		
OUTLET: Adequate outlet for free flow of water from flood plains into channel.		
CLEARING: Objectionable materials removed from channel. As many trees preserved, as possible.		
BUFFERS: Buffers preserved by clearing for spoil placement on one side of channel only. Buffers reestablished with appropriate vegetation.		
MAINTENANCE: Inspected periodically and necessary repairs made immediately.		
Co Construction Exit		
AGGREGATE SIZE: 1.5 to 3.5 inches.		
PAD THICKNESS: 6-inch minimum.		
PAD WIDTH: 20 foot minimum.		
PAD LENGTH: 50 feet minimum.		
LOCATION: At all entrance/exit points.		
GEOTEXTILE: Placed full length and width of the entrance/exit.		
MAINTENANCE: Periodic top dressing with 1.5 to 3.5 inch stone as conditions demand.		

Cr Construction Road Stabilization		
Minimum Requirement	Passed	Failed
AGGREGATE SIZE: 1.5 to 3.5 inches.		
PAD THICKNESS: 8-10-inches.		
PAD WIDTH: 14 feet minimum.		
MAINTENANCE: Periodic top dressing with 1.5 to 3.5 inch stone as conditions demand.		
Dc Stream Diversion Channel		
SIZE: Channel width should be a minimum of 6 feet with side slopes no steeper than 2:1.		
LINING: The liner should consist of Geotextile (Dc-B) or class I riprap (Dc-C).		
MAINTENANCE: Inspected daily for construction material positioning.		
Di Diversion		
SITE PREPARATION: Trees, brush, stumps and other objectionable material have been removed.		
FILLS: All fills compacted. Unneeded excavated material disposed of and stabilized. Ridge should be at least 10 feet wide. Add 10% to height for settlement.		
STABILIZATION: Channel outlets require adequate vegetation, riprap, or pavement.		
MAINTENANCE: Inspected frequently and after each rainfall with necessary repairs made immediately.		

(Dn1) Downstream Structure (Dn2)		
Minimum Requirement	Passed	Failed
LOCATION: On undisturbed soil or well-compacted fill.		
OUTLET: Stabilized with rock riprap.		
PIPE: Heavy-duty flexible tubing staked at 10-foot intervals (Temporary Structure (Dn1)). Joints well-connected and watertight.		
MAINTENANCE: Checked after every rainfall with necessary repairs made promptly. Temporary structure removed when no longer needed. Exposed areas stabilized.		
(Fr) Filter Ring		
SIZE: At inlets with diameters less than 12 inches, the stone size should be 3-5 inches.		
SIZE: At inlets with diameters greater than 12 inches, the stone size should be 10-15 inches.		
HEIGHT: The filter ring should have a minimum height of 2 feet from grade.		
MAINTENANCE: The ring should be kept clear of trash and debris, and the sediment should be removed when one-half full.		
(Ga) Gabion		
DESIGN: Performed by a qualified professional familiar with the use of gabions.		
MAINTENANCE: Periodically inspected for signs of undercutting or excessive erosion.		
(Gr) Grade Stabilization Structure		
MATERIALS: Constructed of concrete, rock, masonry, steel, aluminum, or treated wood.		

Minimum Requirement	Passed	Failed
OUTLET: Adequate, stable outlet for discharges.		
VEGETATION: On all disturbed areas immediately.		
Maintenance: Periodically inspected for signs of undercutting or excessive erosion.		
(Lv) Level Spreader		
GRADE: No greater than 1 % for the last 15 feet of the dike or diversion.		
LENGTH: Determined by plan preparer from estimated storm flow.		
OUTLET: Discharges onto an undisturbed stabilized area to create uniform sheet flow.		
MAINTENANCE: No blockages at point of discharge.		
(Mb) Erosion Control Matting and Blankets		
INSTALLATION: According to manufacturer's specifications.		
Maintenance: check for slumping or failure of material.		
(Rd) Rock Filter Dam		
HEIGHT: Not higher than channel banks with dam center 6 inches lower than outer edges of dam.		
SIDE SLOPES: 2:1 or flatter.		
LOCATION: Located so that it will not cause flooding of upstream property.		

Minimum Requirement	Passed	Failed
ROCK SIZE: Determined by the design criteria established in the riprap section (Appendix C) of the E&SC Manual.		
TOP WIDTH: Should be no less than 6 feet.		
MAINTENANCE: Sediment removed when it reaches a depth of 1/2 the original height of dam. Dam removed at completion of its useful life.		
Re Retaining Wall		
SPECIFIC DESIGN: Performed by capable design engineer or architect.		
MAINTENANCE: Periodically inspected for signs of undercutting or excessive erosion.		
Rt Retrofitting		
HEIGHT: 1/2 the height of the stormwater management structure.		
HALF-ROUND PIPE: Diameter should be 1.5 times the principal pipe outlet diameter.		
SLOTTED BOARD DAM: Posts minimum size of 4"x4". 0.5 to 1 inch spacing between boards.		
STONE SIZE: 3 to 4 inch stone.		
POND INLET: Sediment entry point should be at opposite end of basin from outlet. If not, baffles should be installed.		
MAINTENANCE: Trash and debris hindering drainage has been removed. Sediment removed when structure is 1/3 full. Structure removed when project is stabilized.		

Sd1 Sediment Barrier		
Minimum Requirement	Passed	Failed
LOCATION: Intended for areas where sheet flow occurs. Not installed in areas of concentrated flow. Installed on contour.		
BRUSH: Windrowed on the contour and at the lower perimeter of site. Compacted, if necessary. Filter fabric added, if necessary, to increase efficiency.		
SILT FENCE: Verify fabric and post types. Entrenched 4-6" depending on fence type. Posts spaced at a maximum of 6'.		
HAYBALES: Embedded to a depth of 4". Secured with stakes or bars driven through bales.		
SAND BAGS: Flow between and beneath sandbags minimized. If height exceeds two (2) bags, staked with steel rods.		
MAINTENANCE: Sediment removed at 1/2 barrier capacity and disturbed area stabilized. Barrier removed at end of useful life.		
Sd2 Inlet Sediment Trap		
BLOCK: Blocks wrapped with fabric with #57 wash stone placed on front.		
GRAVEL: Minimum stone diameter of 3 inches on inlet side and #57 stone on opposite side at a thickness of 1 foot.		
FRAME AND FABRIC: Sturdy frame with fabric entrenched and pulled taut.		
MAINTENANCE: Sediment removed when 2/3 fence capacity is reached and stabilize loose soil material.		
Sd3 Temporary Sediment Basin		
LOCATION: Not located in a live stream.		
PRINCIPAL SPILLWAY PIPE: Pipe extended beyond downstream toe of the fill. All pipe joints watertight.		

Minimum Requirement	Passed	Failed
RISER: 1/2 inch perforations 3 inches apart covered with two feet of 1/2 to 3/4 inch stone. Trash rack installed.		
EMERGENCY SPILLWAY: installed in undisturbed soil. Minimum bottom width of 8 feet. Stabilized with vegetation, riprap, or concrete.		
MAINTENANCE: All damages to structure repaired before day's end. Sediment removed when storage capacity has been reduced by 1/3.		
(Sr) Temporary Stream Crossing		
SIZE: Large enough to convey the full bank flow of the stream without appreciably altering the stream flow characteristics.		
OVERFLOW PROTECTION: Elevated crossings, crown fills over pipes, diversions or dikes.		
MAINTENANCE: Inspected after every rainfall or at least once a week with repairs made immediately.		
(St) Storm Drain Outlet Protection		
ALIGNMENT: Contains no bends and aligns with receiving channel.		
SUBGRADE: Constructed on 0.0% grade. Invert and outlet at same elevation as bottom of receiving channel. Compacted fill required.		
FILTER: Gravel filter or geotextile installed between riprap and subgrade. Gravel filter should be properly graded and geotextiles installed in accordance with manufacturer's recommendations.		
MINIMUM DIMENSIONS: Thickness = 3x's max. rock diameter; Width = 3x's outlet pipe diameter; Length = 6x's outlet pipe diameter.		
MAINTENANCE: inspect riprap outlet structures for any dislodged stones causing erosion. Repairs made immediately.		
(Su) Surface Roughening		
SLOPES STEEPER THAN 3:1: Roughened by either stair-step grading, grooving, furrowing, or tracking. Areas to be mowed should have small furrows only.		

Minimum Requirement	Passed	Failed
SLOPES FLATTER THAN 3:1: Soils loosened to a depth of 2 to 4 inches.		
STAIR-STEPPING: Stair-steps should have maximum width of 40"-50" and a maximum depth of 30"-40".		
GROOVING: Installed by equipment operating on the contour (across the slope). Maximum top width of 12"-15" and minimum depth of 3 inches for grooves.		
TRACKING: Tracked equipment operated up and down slope. Heavy clay soils may not track well.		
VEGETATION: Seed, mulch, lime, and fertilizer applied immediately after roughening.		
<p>Topsoiling</p>		
STRIPPING: Confined to the immediate construction area. Only friable, loamy topsoil stripped. Objectionable rock and roots removed.		
STOCKPILES: Vegetated and mulched and located in areas not obstructing natural drainage.		
SPREADING: Areas prepared by tilling or scarifying. Lime and fertilizer added as required. Topsoil handled when it is not too wet. A 5 inch depth of loose soil is desirable.		
VEGETATION: Vegetation and mulch applied immediately.		
<p>Vegetated Waterway</p>		
CHANNEL: Free of all trees, rocks, brush, and other debris. Shaped to desired cross-section. Protected from erosion during establishment by diversions, geotextiles, etc.		
FILL MATERIAL: Compacted. Excess fill material disposed of in a suitable manner and vegetated.		
VEGETATION: Seed, mulch, lime and fertilizer applied immediately.		

Bf Buffer Zone		
Minimum Requirement	Passed	Failed
WIDTH: Minimum of 25 feet on all state waters; 50 feet on streams designated as "Trout Waters" unless variance is obtained. See Law for specifics.		
MAINTENANCE: Buffers protected from equipment encroachment. Sediment removed when effectiveness is lost.		
Cs Coastal Dune Stabilization		
LOCATION: 100 feet from mean high tide line.		
POSTS: Minimum length of 7' with minimum diameter of three inches; slats spaced approximately 1 1/4 inches apart.		
SPACING: Two or more parallel 4-foot high fences spaced from 30 to 40 feet apart.		
PLACEMENT: 30-foot sections of fence installed perpendicular to the prevailing winds.		
VEGETATION: Installed immediately following dune development. Mulch applied and irrigated, if necessary.		
PRESERVATION: Dunes protected from human and vehicular traffic.		
Ds1 Disturbed Area Stabilization (With Mulching Only)		
SOIL PREPARATION: Loosed to a depth of 3", if possible.		
ANCHORING: Mulch anchored with a "packer disk" or with an emulsifier.		
EMULSIFIER MIXTURE: 100 gallons of emulsifier per ton of mulch.		
MATERIALS AND RELATED DEPTHS: Straw or hay - 2" to 4" depth. Pine needles - 4" to 6" depth. Wood chips, sawdust - 2" to 3" depth. Shredded leaves - 2" to 3" depth.		

Minimum Requirement	Passed	Failed
COMMERCIAL MATTING OR NETTING: Followed manufacturer's specifications.		
<div style="display: flex; align-items: center; justify-content: center;"> <div style="border: 1px solid black; padding: 5px; margin-right: 10px; font-weight: bold; font-size: 1.2em;">Ds2</div> <div style="text-align: center;"> <h3>Disturbed Area Stabilization</h3> <p>(With Temporary Seeding)</p> </div> </div>		
SEEDBED PREPARATION: Soil should be loose and friable.		
LIME AND FERTILIZER: Fertilizer may be needed when low fertility conditions exist (500-700 pounds of 10-10-10 per acre).		
SEEDING: Vegetation selected is suitable to the area and season of the year.		
GERMINATION: Tag on bag should be checked and a simple germination test should preclude plantings.		
MULCH: Placed after seeding to retain moisture and protect seed.		
<div style="display: flex; align-items: center; justify-content: center;"> <div style="border: 1px solid black; padding: 5px; margin-right: 10px; font-weight: bold; font-size: 1.2em;">Ds3</div> <div style="text-align: center;"> <h3>Disturbed Area Stabilization</h3> <p>(With Permanent Vegetation)</p> </div> </div>		
SEEDBED PREPARATION: Needed when the soil has been sealed from crusting or when conventional seeding is used.		
LIME AND FERTILIZER: Rates of 1-2 tons of lime per acre with fertilizer rates following Field Manual recommendations.		
SEEDING: Refer to appropriate planting tables. Companion crops may be required for areas needing quick cover.		
INOCULANTS: All legume seed should be inoculated and careful attention given to it's handling.		
MULCH: Dry straw applied at a rate of 2 tons per acre, and dry hay at a rate of 2 1/2 tons per acre. 75% of soil surface covered.		
MULCH ANCHORING: 100 gallons emulsified asphalt per ton of mulch, "packer disk," or synthetic netting.		

Minimum Requirement	Passed	Failed
MOWING: 6" minimum height maintained.		
FUTURE FERTILIZER RATES: Refer to the Manual for second year fertilizer rates.		
<div style="display: flex; align-items: center;"> <div style="border: 1px solid black; padding: 5px; margin-right: 10px;">Ds4</div> <div> Disturbed Area Stabilization (With Sodding) </div> </div>		
SURFACE: Surface at final grade. Surface clear of trash and other objects larger than 1 inch.		
INSTALLATION: Sod applied to soil surface only (not to frozen or gravel-type soils). Certified sod cut used within 36 hours.		
LIME AND FERTILIZER: Based on soil test. Applied according to recommendations.		
ANCHORING: Anchored with pins if slopes are steeper than 3:1.		
IRRIGATION: Rainfall supplemented with irrigation, if necessary.		
<div style="display: flex; align-items: center;"> <div style="border: 1px solid black; padding: 5px; margin-right: 10px;">Du</div> <div> Dust Control </div> </div>		
METHODS: Mulch, vegetation or tackifiers applied or surface sprayed with water until it is thoroughly wet.		
<div style="display: flex; align-items: center;"> <div style="border: 1px solid black; padding: 5px; margin-right: 10px;">Sb</div> <div> Streambank Stabilization (Using Permanent Vegetation) </div> </div>		
DESIGN: Designed and installed by professionals familiar with process.		
MATERIALS: None used that could be poisonous to fish and aquatic life (i.e. asphalt, wood treated with creosote)		
RUNOFF: Intensive runoff diverted from the area being treated.		
SIDE SLOPE: 2:1 or flatter. Refer to <u>Guidelines</u> for recommended slope lengths.		

Minimum Requirement	Passed	Failed
WORK SEQUENCE: Work starts upstream at a stable point along the bank.		
STAKE HEALTH: Cut with a saw. Planted same day as prepared. Buds upward. Split, stripped, and mushroomed cuttings replaced.		
STAKE INSTALLATION: Begins at water's edge and works up the bank.		
VEGETATION: Native trees and shrubs. Failures fixed at once with structural materials or new plants, mulching if necessary.		
INSPECTION: Checked regularly for wash-outs, undercutting, unhealthy vegetation, especially after heavy rains. Make necessary repairs immediately.		
<div style="border: 1px solid black; display: inline-block; padding: 2px 10px; margin-right: 10px;">Tb</div> Tackifiers and Binders		
SPECIFICATIONS: Tackifiers and Binders are used to anchor wood cellulose, wood pulp fiber, and other mulch materials applied with hydroseeding equipment.		

GLOSSARY

The list of terms that follows is representative of those used by soil scientists, engineers, developers, conservationist planners, etc. The terms are not necessarily used in the text, nonetheless they are in common use in conversation matters.

AASHTO CLASSIFICATION (*soil engineering*) -- The official classification of soil materials and soil aggregate mixtures for highway construction used by the American Association of State Highway Transportation Officials.

ACID SOIL -- Soil with a pH value less than 7.0. The term is usually applied to the surface layer or to the root zone unless specified otherwise.

ACRE-FOOT -- The volume of water that will cover 1 acre to a depth of 1 foot.

ALKALINE SOIL -- A soil that has a pH greater than 7.0, particularly above 7.3.

ALLUVIAL -- Pertaining to material that is transported and deposited by running water.

ANTI-SEEP COLLAR -- A device constructed around a pipe or other conduit and placed through a dam, levee or dike for the purpose of reducing seepage losses and piping failures.

ANTI-VORTEX DEVICE -- A facility placed at the entrance to a pipe conduit structure, such as a drop inlet spillway or hood inlet spillway, to prevent air from entering the structure when the pipe is flowing full.

APRON (*soil engineering*)-- A floor or lining to protect a surface from erosion. An example is the pavement below chutes, spillways, or at the toes of dams.

AUXILIARY SPILLWAY -- A dam spillway built to carry runoff in excess of that carried by the principal spillway. See *Emergency Spillway*.

BACKFILL -- The material used to refill a ditch or other excavation, or the process of doing so.

BEDLOAD -- The sediment that moves by sliding, rolling or bounding on or very near the streambed.

BEST MANAGEMENT PRACTICES (BMPs) -- A collection of structural practices and vegetative measures which, when properly designed, installed and maintained, will provide effective erosion and sedimentation control for all rainfall events up to and including a 25-year, 24-hour rainfall event.

BORROW AREA -- A source of earth fill material.

BRUSH MATTING -- (1) A matting of branches placed on badly eroded land to conserve moisture and reduce erosion while trees or other vegetative covers are being established. (2) A matting of mesh wire and brush used to retard stream bank erosion.

- CHANNEL -- A natural stream that conveys water; a ditch or channel excavated for the flow of water. See *Watercourse*.
- CHANNEL IMPROVEMENT -- The improvement of the flow characteristics of a channel by clearing, excavating, realignment, lining, or other means.
- CHANNEL SLOPE -- Natural or excavated sides (banks) of a watercourse.
- CHANNEL STABILIZATION -- Erosion prevention and stabilization of velocity distribution in a channel using jetties, drops, revetments, vegetation, and other measures.
- COMPACTION -- The process by which soil grains are rearranged to decrease void space and bring them into closer contact with one another, thereby increasing the weight of solid material per cubic foot.
- CONDUIT - - Any channel intended for the conveyance of water, whether open or closed.
- CONSERVATION -- The protection, improvement and use of natural resources according to principles that will assure their highest economic or social benefit.
- CONSERVATION DISTRICT -- An agency of state government created to develop and carry out a program of soil, water and related resource conservation use and development within its boundaries.
- CONTOUR -- (1) An imaginary line on the surface of the earth connecting points of the same elevation. (2) A line drawn on a map connecting points of the same elevation.
- COVER CROP -- A close growing crop protecting and improving soil between periods of permanent vegetation.
- CRITICAL AREA -- A severely eroded, sediment-producing area that requires special management to establish and maintain vegetation.
- CUT -- A portion of land surface or area from which earth has been removed or will be removed by excavation; the depth below the original ground surface to the excavated surface. Syn. *Excavation*.
- CUT-AND-FILL - - Process of earth moving by excavating part of an area and using the excavated material for adjacent embankments or fill areas.
- CUTOFF -- A wall, collar or other structure, such as a trench, filled with relatively impervious material intended to reduce seepage of water through porous strata.
- DAM -- A barrier to confine or raise water for storage or diversion.
- DEBRIS -- The loose material arising from the disintegration of rocks and vegetative material; transportable by streams, ice, or floods.
- DEBRIS DAM -- A barrier built across a stream channel to retain rock, sand, gravel, silt, or other material.
- DEGRADATION -- To wear down by erosion, especially through stream action.
- DESIGN LIFE -- The period of time for which a facility is expected to perform its intended function.

- DESILTING AREA** -- An area of grass, shrubs or other vegetation used for deposition of silt and other debris from flowing water.
- DETENTION DAM** -- A dam constructed for the purpose of temporary storage of streamflow or surface runoff and for releasing the stored water at controlled rates.
- DISCHARGE** (*hydraulics*) -- The volume of fluid passing a point per unit time, commonly expressed as cubic feet per second, million gallons per day, gallons per minute, or cubic meters per second.
- DIVERSION** -- A channel, with or without a supporting ridge on the lower side, constructed across the top or bottom of a slope to intercept surface runoff.
- DIVERSION DAM** -- A barrier built to divert part or all of the water from a stream into a different course.
- DRAIN** -- (1) A buried pipe or other conduit (closed drain). (2) A ditch (open drain) for carrying off surplus surface water or groundwater. (3) To provide channels, such as open ditches or closed drains, so that excess water can be removed by surface flow or by internal flow. (4) To lose water (from the soil) by percolation.
- DRAINAGE** -- (1) The removal of excess surface water or ground water from land by means of surface or subsurface drains. (2) Soil characteristics that affect natural drainage.
- DROP-INLET SPILLWAY** -- An overfall in which the water drops through a vertical riser connected to a discharge conduit.
- DROP SPILLWAY** -- An overfall structure in which the water drops over a vertical wall onto an apron at a lower elevation.
- DROP STRUCTURE** -- A structure for dropping water to a lower level and dissipating its surplus energy; a fall. A drop may be vertical or inclined.
- EARTH DAM** -- Dam constructed of compacted soil material.
- EMBANKMENT** -- A man-made deposit of soil, rock, or other material used to form an impoundment.
- EMERGENCY SPILLWAY** -- A spillway used to carry runoff exceeding a given design flood. Syn. *Auxiliary Spillway*.
- ENERGY DISSIPATOR** -- A device used to reduce the energy of flowing water.
- ERODIBLE** (*geology and soils*) -- Susceptible to erosion.
- EROSION** -- (1) The wearing away of the land surface by running water, wind, ice, or other geological agents, including such processes as gravitational creep. (2) Detachment and movement of soil or rock fragments by water, wind, ice or gravity. The following terms are used to describe different types of water erosion:
- ACCELERATED EROSION** -- Erosion much more rapid than normal, primarily as a result of the influence of the activities of man.
- GEOLOGICAL EROSION** -- The normal or natural erosion caused by geological processes acting over long geologic periods.

- GULLY EROSION** -- The erosion process whereby water accumulates in narrow channels and, over short periods, removes the soil from this narrow area.
- NATURAL EROSION** -- Wearing away of the Earth's surface by water, ice, or other natural agents under natural environmental conditions.
- NORMAL EROSION** -- The gradual erosion of land used by man which does not greatly exceed natural erosion.
- RILL EROSION** - An erosion process in which numerous small channels, only several inches deep, occur mainly on recently disturbed and exposed soils.
- SHEET EROSION** - The removal of a fairly uniform layer of soil from the land surface by runoff water.
- SPLASH EROSION** - The spattering of small soil particles caused by the impact of raindrops on wet soils.
- EROSION AND SEDIMENTATION CONTROL PLAN** - A plan for the control of erosion and sediment resulting from a land-disturbing activity.
- EROSIVE** - Having sufficient velocity to cause erosion; refers to wind or water. Not to be confused with *erodible* as a quality of soil.
- EXISTING GRADE** -- The vertical location of the existing ground surface prior to cutting or filling.
- FERTILIZER** -- Any organic or inorganic material of natural or synthetic origin that is added to a soil to supply elements essential to growth.
- FERTILIZER ANALYSIS** -- The percentage composition of fertilizer, expressed in terms of nitrogen (N), phosphoric acid (P), and potash (K).
- FILLING** -- The placement of any soil or other solid material, either organic or inorganic, on a natural ground surface or an excavation.
- FILTER STRIP** -- A long, narrow vegetative planting used to retard or collect sediment.
- FINAL CUT** -- The last cut or line of excavation made when mining a specific property or area.
- FINISHED GRADE** -- The final grade or elevation of the ground surface.
- FLOODPLAIN** -- Nearly level land situated on either side of a channel subject to overflow flooding.
- FREEBOARD** (*hydraulics*) -- Vertical distance between the maximum water surface elevation anticipated in design and the top of retaining banks or structures. Provided to prevent overtopping because of unforeseen conditions.
- GEOTEXTILE** -- A term used to describe woven or non-woven fabric materials used to reinforce or separate soil and other materials.
- GRADE** -- (1) The slope of a road, channel, or natural ground. (2) The finished surface of a canal bed, roadbed, top of embankment, or bottom of excavation; any surface prepared for the support of construction like paving or laying a conduit. (3) To finish the surface of a canal bed, roadbed, top of embankment, or bottom of excavation.

- GRADE STABILIZATION STRUCTURE** -- A structure stabilizing the grade of a gully or other watercourse, thereby preventing further headcutting or lowering of the channel grade.
- GRADIENT** -- Change of elevation, velocity, pressure or other characteristics per unit length; slope.
- GRADING** -- Altering surfaces to specified elevations, dimensions, and/or slopes.
- GRASSED WATERWAY** -- A natural or constructed waterway, usually broad and shallow, covered with erosion-resistant grasses, used to conduct surface water from cropland.
- GULLY** -- A channel or miniature valley cut by concentrated runoff sufficiently deep that it would not be obliterated by normal tillage operations, whereas a rill is of lesser depth and would be smoothed out by use of ordinary tillage equipment.
- INTERMITTENT STREAM** -- A stream, or portion of a stream, that flows only in direct response to precipitation. It receives little or no water from springs and no long-continued supply from melting snow or other sources. It is dry for a large part of the year, ordinarily more than three months.
- LAND-DISTURBING ACTIVITY (LDA)** -- Any land change which may result in soil erosion from water or wind and the movement of sediments into State water or onto lands within the State, including, but not limited to, clearing, dredging, grading, excavating, transporting, and filling of land.
- LEGUME** -- A member of the legume or pulse family, such as the peas, beans, peanuts, clover, alfalfas, sweet clovers, lespedezas, vetches and kudzu. Practically all legumes are nitrogen-fixing plants.
- LEVEL SPREADER** -- A shallow channel excavation at the outlet end of a diversion with a level section for the purpose of diffusing the diversion outflow.
- LIME** -- From the strictly chemical standpoint, refers to only one compound, calcium oxide (CaO); however, the term "lime" can include a great variety of materials which are usually composed of the oxide, hydroxide or carbonate of calcium or of calcium and magnesium.
- LITTER** -- A surface layer of loose organic debris in forests consisting of freshly fallen or slightly decomposed organic materials.
- MULCH** -- A natural or artificial layer of plant residue or other materials, such as sand or paper, on the soil surface.
- OUTLET** -- Point of water disposal from a stream, river, lake, tidewater, or artificial dam.
- OUTLET CHANNEL** -- A waterway constructed or altered primarily to carry water from man-made structures, such as terraces, tile lines, and diversions.
- PEAK DISCHARGE** -- The maximum instantaneous flow from a given storm condition at a specific location.
- PERMEABILITY, SOIL** -- The quality of soil that enables water or air to move through it.

pH -- A numerical measure of the acidity or hydrogen ion activity. The neutral point is pH 7.0. All pH values below 7.0 are acid and all above are alkaline.

PIPE DROP -- A circular conduit used to convey water down steep grades.

PRINCIPAL SPILLWAY -- A water-conveying device designed to regulate the normal water level.

PURE LIVE SEED (PLS) -- A term used to express the quality of seed, even if it is not shown on the label. Expressed as a percentage of the seeds that are pure and will germinate. Determined by multiplying the percent of pure seed times the percent of germination and dividing by 100.

Example: Common bermuda seed: 70% germination, 80% purity.

$$\text{PLS} = \frac{70\% \text{ germination} * 80\% \text{ purity}}{100}$$

$$\text{PLS} = 56/100 = .56 = 56\%$$

RILL -- A small intermittent watercourse with steep sides, usually only a few inches deep.

RIPRAP -- Broken rocks, cobbles, or boulders placed on earth surfaces, such as the face of a dam or the bank of a stream for protection against the action of water.

RISER -- The inlet portions of a drop inlet spillway that extend vertically from the pipe conduit barrel to the water surface.

ROCK-FILL DAM -- A dam composed of loose rock usually dumped in place, often with the upstream part constructed of hand-placed or derrick-placed rock, and faced with rolled earth or with an impervious surface of concrete, timber, or steel.

RUNOFF (*hydraulics*) -- That portion of the precipitation on a drainage area that is discharged from the area in stream channels.

SCARIFY -- To abrade, scratch or modify the surface; for example, to scratch the impervious seed coat of a hard seed or to break the surface of the soil with a narrow-bladed instrument.

SEDIMENT -- Solid material, both mineral and organic, that is in suspension, is being transported, or has been moved from its site of origin by air, water, gravity, or ice as a product of erosion.

SEDIMENT BASIN -- A depression formed from the construction of a barrier or dam built at a suitable location to retain sediment and debris.

SEEDBED -- The soil prepared by natural or artificial means to promote the germination of seed and the growth of seedlings.

SHEET FLOW -- Water, usually storm runoff, flowing in a thin layer over the ground surface; also called overland flow.

SIDE SLOPE -- Generic term used to describe the slope of earth-moving operations, generally stated in horizontal to vertical ratio.

- SILT** -- (1) A soil separate consisting of particles between 0.05 and 0.02 millimeter in equivalent diameter. (2) A soil textural class.
- SLOPE** -- The degree of deviation of a surface from horizontal, measured in numerical ratio, percent, or degrees. Expressed as a ratio or percentage, the first number is the horizontal distance (run) and the second is the vertical distance (rise), as 2:1 or 50 percent (rise/run X 100%). Expressed in degrees, it is the angle of the slope from the horizontal plane with a 90 degree slope being vertical (maximum) and 45 degrees being a 1:1 slope.
- SOIL** -- The unconsolidated mineral and organic material on the immediate surface of the Earth that serves as a natural medium for the growth of land plants.
- SPILLWAY** -- An open or closed channel, or both, used to convey excess water from a reservoir.
- SPOIL** -- Soil or rock material excavated from a canal, ditch, basin, or similar construction.
- STABILIZATION** -- The process of establishing an enduring soil cover of vegetation and/or mulch or other ground cover in combination with installing temporary or permanent structures to minimize transport of sediment by wind, water, ice, or gravity.
- STABILIZED GRADE** -- The slope of a channel at which neither erosion, nor deposition, occurs.
- STAGE** (*hydraulics*) -- The variable water surface or the water surface elevation above any chosen datum
- STATE SOIL AND WATER CONSERVATION COMMISSION** -- The State agency established by the Soil and Water Conservation District Enabling Act to administer that law.
- STORM DRAIN OUTLET PROTECTION** -- A device used to dissipate the energy of flowing water.
- STORM FREQUENCY** -- An expression or measure of how often a hydrologic event of a given size or magnitude should on an average occur, based on a reasonable sample.
- STREAMBANKS** -- The usual boundaries, not the flood boundaries, of a stream channel. Right and left banks are named facing downstream.
- STRUCTURAL PRACTICES** -- Soil and water conservation measures, other than vegetation, utilizing the mechanical properties of matter to change the surface of the land to store, regulate, or dispose of runoff to prevent excessive sediment loss. This includes, but is not limited to, riprap, sediment basins, dikes, level spreaders, waterways or outlets, diversions, grade stabilization structures, sediment traps, land grading, etc.
- SUBWATERSHED** -- A watershed subdivision of unspecified size that forms a convenient natural unit.
- TILTH** -- A soil's physical condition as related to its ease to work (till).
- TOPSOIL** -- Earthy material used as top-dressing for house lots, grounds for large buildings, gardens, road cuts or similar areas. It has favorable characteristics for production of desired kinds of vegetation or can be made favorable.

- TRASH RACK** - - A structural device used to prevent debris from entering a spillway or other hydraulic structure.
- UNIFIED SOIL CLASSIFICATION SYSTEM** (*engineering*) -
- A classification system based on the identification of soils according to their particle size, gradation, plasticity index, and liquid limit.
- UNIFORM FLOW** -- A state of steady flow when the mean velocity and cross-sectional area are equal to all sections of each.
- VEGETATIVE MEASURES** -- Stabilization of erosive or sediment-producing areas by covering the soil with: (a) permanent seeding, producing long-term vegetative cover or (b) short-term seeding, producing temporary vegetative cover or (c) sodding, producing areas covered with a turf or perennial sod, forming grass.
- WATER CONSERVATION** -- The physical control, protection, management, and use of water resources in such a way as to maintain maximum sustained benefits to people, agriculture, industry, commerce and other segments of the economy.
- WATERCOURSE** -- Any natural or artificial watercourse, stream, river, creek, channel, ditch, canal, conduit, drain, waterway, gully, ravine, or wash in which water flows either continuously or intermittently, and which has a definite channel, bed and banks, including any area adjacent thereto subject to inundation by reason of overflow or floodwater.
- WATERSHED AREA** -- All land and water within the confines of a drainage divide, or a water problem-area consisting in whole, or in part, of land needing drainage or irrigation.
- WEIR** -- Device for measuring or regulating the flow of water.

This glossary was compiled from definitions supplied by the Georgia Soil and Water Conservation Commission, Natural Resources Conservation Service, Soil and Water Conservation Society of America, Resource Conservation Glossary and other state and federal publications.

(This page left blank intentionally.)

Georgia Points of Contact

GEORGIA SOIL AND WATER CONSERVATION COMMISSION REGIONAL OFFICES

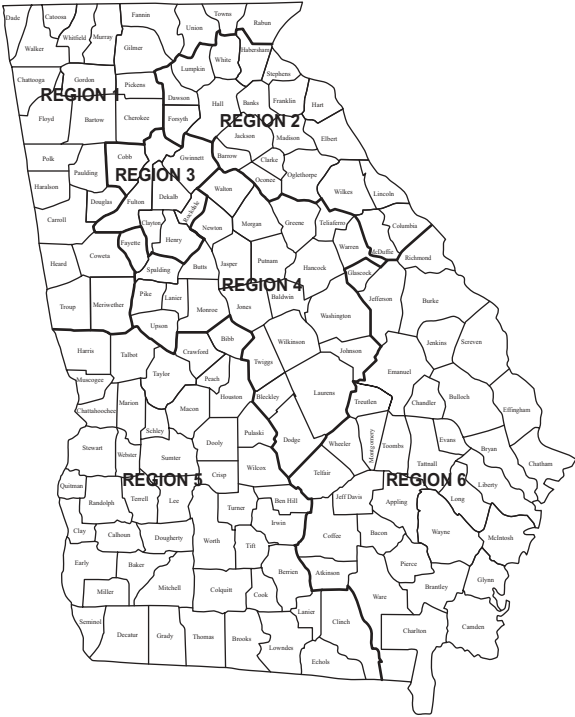

Region 1

700 East 2nd Avenue, Suite J
Rome, Georgia 30161-3359
Phone: 706-295-6131

Region 3

1500 Klondike Road
Suite A109
Conyers, Georgia 30094
Phone: 770-761-3020

Region 5

2700 Palmyra Road
Albany, Georgia 31707-1845
Phone: 229-430-4408

Region 2

P.O. Box 8024
Athens, Georgia 30603
Phone: 706-542-9233

Region 4

3014 Heritage Road, Suite 1
Milledgeville, Georgia 31061
Phone: 478-445-5766

Region 6

117 Savannah Avenue
Stateboro, Georgia 30458
Phone: 912-681-5241

GEORGIA DEPARTMENT OF NATURAL RESOURCES ENVIRONMENTAL PROTECTION DIVISION

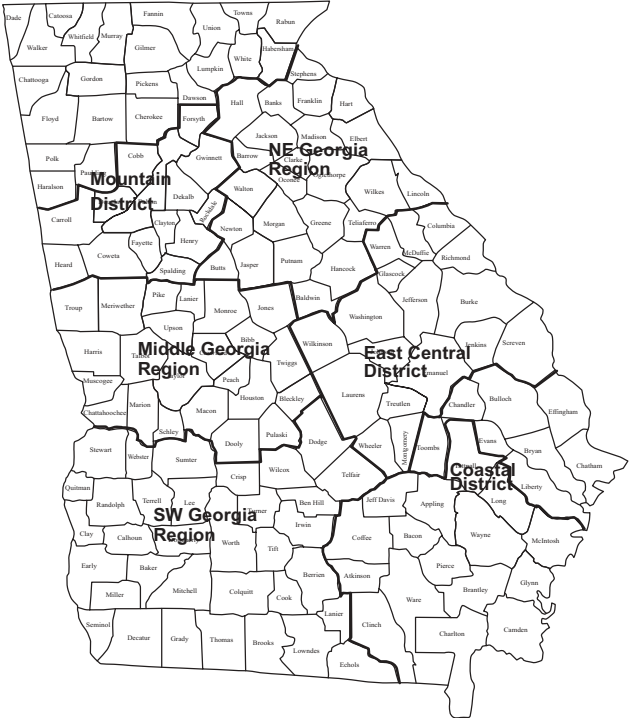

Mountain District
 (Mail) P.O. Box 3250
 Cartersville, Georgia 30120
 (Street) 16 Center Road
 Cartersville, Georgia 30121
 Phone: 770-387-4900

Tradeport Office Park, Suite 114
 4244 International Parkway
 Atlanta, Georgia 30354
 Phone: 404-362-2671

Middle Georgia Region
 2640 Shurling Drive
 Macon, Georgia 31211
 Phone: 478-751-6612

Southwest Georgia Region
 2024 Newton Road
 Albany, Georgia 31701
 Phone: 229-430-4144

Northeast Georgia Region
 745 Gaines School Road
 Athens, Georgia 30605
 Phone: 706-369-6376

East Central District
 1885 Tobacco Road
 Augusta, Georgia 30906
 Phone: 706-792-7744

Coastal District
 One Conservation Way
 Brunswick, Georgia 31520
 Phone: 912-264-7284

Abercorn Center
 6555 Abercorn Street
 Suite 130
 Savannah, Georgia 31405
 Phone: 912-353-3225

GEORGIA DEPARTMENT OF NATURAL RESOURCES WILDLIFE RESOURCES DIVISION FISHERIES MANAGEMENT SECTION

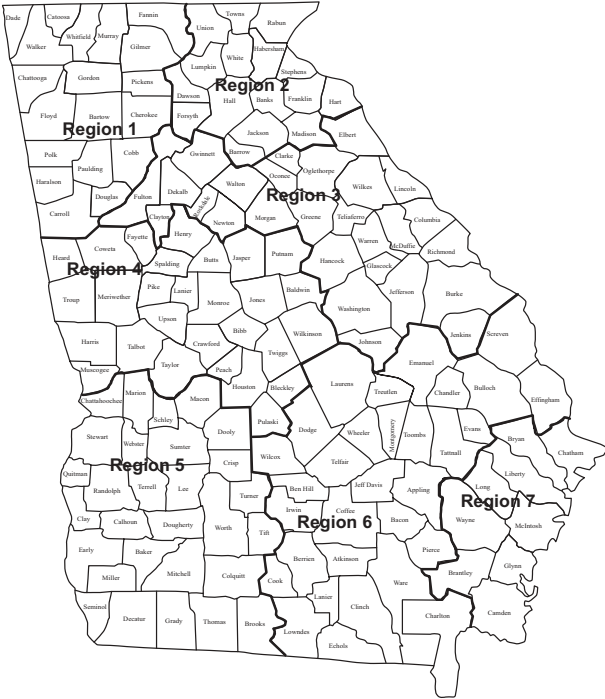

Region 1 — Northwestern
P.O. Box 519
Calhoun, Georgia 30703
Phone: 706-629-1259

Region 2 — Northeastern
2150 Dawsonville Highway
Gainesville, Georgia 30501
Phone: 770-535-5498

Region 3 — East Central
2123 U.S. Highway 278, S.E.
Social Circle, Georgia 30025
Phone: 770-918-6418

Region 4 — West Central
1014 Martin Luther King Jr.
Blvd.
Fort Valley, Georgia 31030
Phone: 478-825-6151

Region 5 — Southwestern
2024 Newton Road
Albany, Georgia 31701
Phone: 229-430-4256

Region 6 — South Central
P.O. Box 2089
Waycross, Georgia 31502
Phone: 912-285-6094

Region 7 — Coastal
22814 Highway 144
Richmond Hill, Georgia 31324
Phone: 912-727-2112

GEORGIA DEPARTMENT OF TRANSPORTATION DISTRICT OFFICES

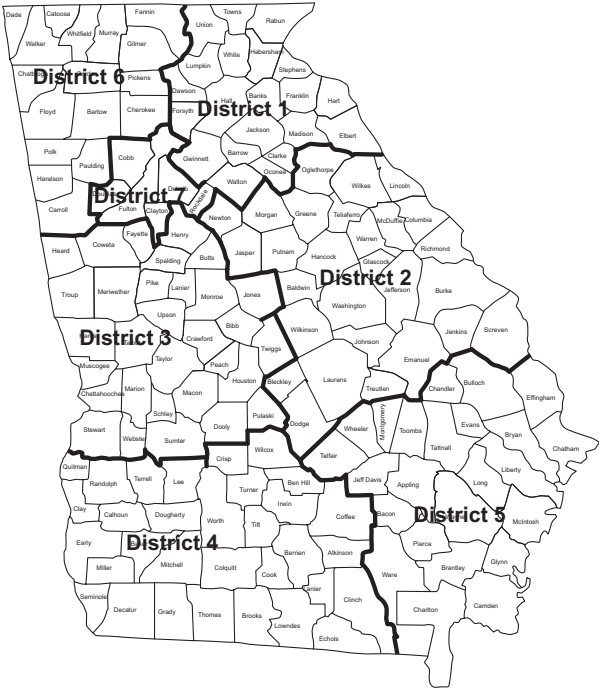

District 1 — Gainesville, GA
P.O. Box 1057
Gainesville, Georgia 30503
Phone: 770-532-5526

District 2 — Tennille, GA
801 Fourth Street
P.O. Box 8
Tennille, Georgia 31089
Phone: 912-552-4600

District 3 — Thomaston, GA
715 Andrews Drive
Thomaston, Georgia 30286
Phone: 706-646-6500

District 4 — Tifton, GA
710 West Second Street
P.O. Box 7510
Tifton, Georgia 31793-7510
Phone: 229-386-3300

District 5 — Jesup, GA
204 North Highway 301
P.O. Box 608
Jesup, Georgia 31546
Phone: 912-427-5711

District 6 — Cartersville, GA
500 Joe Frank Harris Pkwy, S.E.
P.O. Box 10
Cartersville, Georgia 30120
Phone: 770-387-3602

District 7 — Chamblee, GA
5025 New Peachtree Road, N.E.
Chamblee, Georgia 30341
Phone: 770-986-1001

GEORGIA FORESTRY COMMISSION WATER QUALITY DISTRICTS

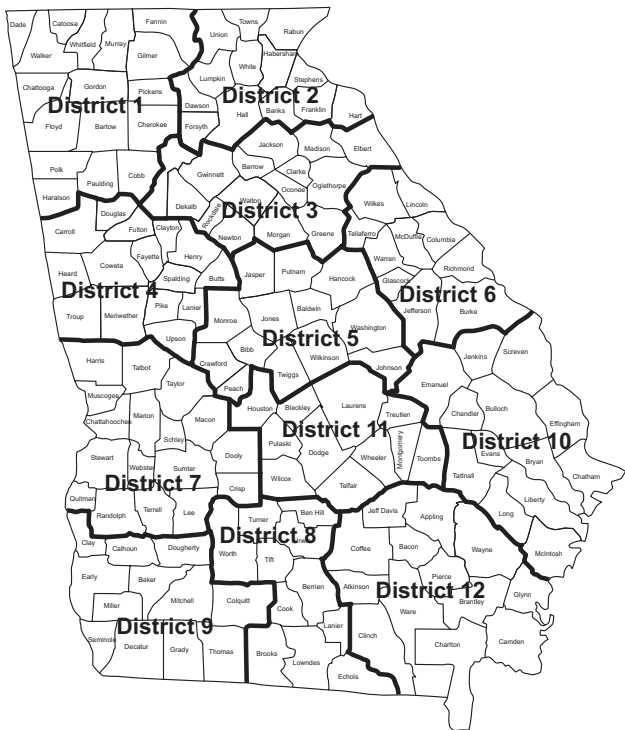

District 1 — Rome, GA
Phone: 706-295-6021

District 2 — Gainesville, GA
Phone: 770-531-6043

District 3 — Athens, GA
Phone: 706-542-6880

District 4 — Newman, GA
Phone: 770-254-7218

District 5 — Milledgeville, GA
Phone: 478-445-5164

District 6 — Washington, GA
Phone: 706-678-2015

District 7 — Americus, GA
Phone: 229-931-2436

District 8 — Tifton, GA
Phone: 229-386-3617

District 9 — Camilla, GA
Phone: 229-522-3580

District 10 — Statesboro, GA
Phone: 912-681-5347

District 11 — McRae, GA
Phone: 912-868-5649

District 12 — Waycross, GA
Phone: 912-287-4915

UNITED STATES
ARMY CORPS OF ENGINEERS
GEORGIA AREA SECTIONS

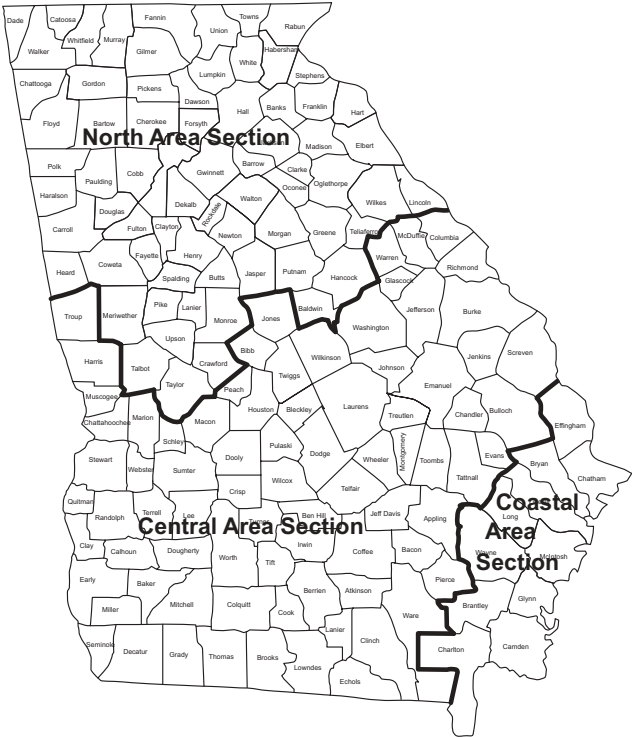

Central and Coastal Area Sections (Southern Section)

U.S. Army Corps of Engineers
Attention: Regulatory Branch
P.O. Box 889
Savannah, Georgia 31402-0889
Phone: 912-652-5065
1-800-448-2402

North Area Section

U.S. Army Corps of Engineers
Attention: Regulatory Branch
Plaze 1590 Adamson Parkway
Suite 130
Morrow, Georgia 30260
Phone: 678-422-2721

GEORGIA NATURAL RESOURCES CONSERVATION SERVICE AREA OFFICES

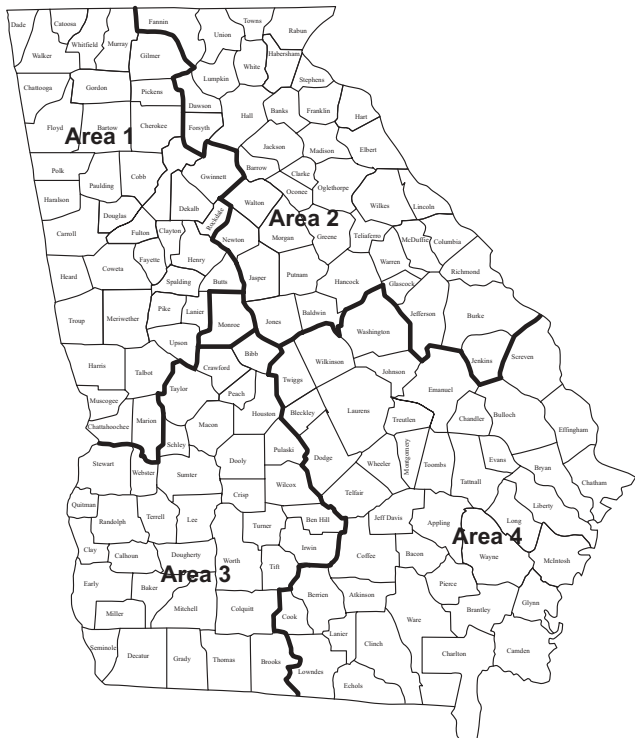

Area 1

Federal Building, Room G-27
P.O. Box 115
Griffin, Georgia 30224-3037
Phone: 770-227-1026

Area 2

355 East Hancock Avenue Mail Stop 211
Athens, Georgia 30601
Phone: 706-546-2039

Area 3

295 Morris Drive
Americus, Georgia 31709
Phone: 229-924-0042

Area 4

Federal Building, Room 214
601 Tebeau Street
Waycross, Georgia 31502-4701
Phone: 912-283-5598

Comments: _____

Comments: _____
